

Interactive Flat Panel



TABLE OF CONTENTS

SAFETY	5
Safety Instructions	5
Copyright	6
Disclaimer	6
Trademark Recognition	6
FCC Statement	6
FCC Warning	6
Declaration of Conformity for EU Countries	7
WEEE	7
ENERGY STAR	7
INTRODUCTION	8
Package Contents	8
Standard Accessories	8
Optional Accessories	9
Product Overview	10
Front View	10
Rear View	11
Remote Control	12
SETUP AND INSTALLATION	14
Wall Mounting Installation	14
Wall Mount Specifications	14
Installing an External Mini Computer	17
Stand Mounting Installation (Optional)	18
Using the Remote Control	21
Installing/Replacing the Remote Control Batteries	21
Remote Control Operating Range	22
Connections	23
Connecting to Power	23
Connecting External Devices	23
USING THE DEVICE	28
Turning the Power On/Off	28
Setup Wizard	29
BASIC OPERATIONS	31
Home Screen Overview	31
Setup Menu	32
Selecting an Input Source	33
Adjusting the Backlight Level	33
Activating the Low Blue Light Function	34

Adjusting the Volume Level	34
Configuring OSD Settings	35
Configuring Image Settings	35
Configuring Display Settings	36
Configuring Signal Settings (for VGA input only).....	37
Configuring Audio Settings	37
Viewing Device Information	38
Configuring Advanced Settings	39
Personalizing the System	40
Configuring Network Settings	41
Configuring Device Settings	43
Configuring Security Settings	45
Configuring System Settings	47
Side Toolbar.....	51
Viewing Recent Tasks	52
Team Share App.....	53
Annotation App	58
Screen Freezing	59
Screen Recorder	60
Floating Annotation Toolbar	60

USING THE APPS 61

TapCast Pro.....	62
TapCast Pro App Compatibility Table	62
Mobile Device	62
Computer.....	64
TapCast Pro Advanced Settings.....	66
File Manager	68
Managing Files	68
Cloud Storage	70
Playing Multimedia Files.....	71
Screen Lock.....	75
Chrome	75
Joan on TV.....	76

ADDITIONAL INFORMATION 80

Dimensions.....	80
65-inch.....	80
75-inch.....	81
86-inch.....	82
Supported Timing List.....	83
RS232 Protocol Function List.....	84
RS232 Pin Assignments.....	84
RS232 RJ45 Control Connection	84
SET Command	85
GET Command	87
LED Indicator.....	89
Troubleshooting.....	90
Maintenance	91

Cleaning the Screen	91
Clean the Front Frame	91
Optoma Global Offices	92

SAFETY

Please follow all warnings, precautions and maintenance as recommended in this user manual.

Safety Instructions

- Only use attachments/accessories specified by the manufacturer.
- Do not block any ventilation openings. To ensure reliable operation of the device and to protect from overheating, it is recommended to install the device in a location that does not block ventilation. Do not put the device in an enclosure such as a book case or a cabinet that restricts air flow.
- Do not use the device near water or moisture. To reduce the risk of fire and/or electric shock, do not expose the device to rain or moisture.
- Do not install near heat sources such as radiators, heaters, stoves or any other apparatus, such as amplifiers, that emits heat.
- Do not let objects or liquids enter the device. They may touch dangerous voltage ports or short out parts that could result in fire or electric shock.
- Do not place the device on an unstable surface. The device may fall over, resulting in injury or the device may become damaged.
- Do not setup the device in places where it might be subjected to vibration or shock.
- Do not use any hard or sharp object to operate the touch screen.
- Do not use the device if it has been physically damaged or abused. Physical damage/abuse would be (but not limited to):
 - The device has been dropped.
 - Power supply cord or plug has been damaged.
 - Liquid has been spilled on to the device.
 - The device has been exposed to rain or moisture.
 - Something has fallen in the device or something is loose inside.
- Do not attempt to service the device yourself. Opening or removing covers may expose you to dangerous voltages or other hazards. Please call Optoma before you send the device for repair.
- Disconnect the power plug from AC outlet if the device is not being used for a long period of time.
- Remove the batteries from the remote control before storage. If the batteries are left in the remote for long periods, they may leak.
- Turn off and unplug the power plug from the AC outlet before cleaning the device.
- Use a soft dry cloth with mild detergent to clean the display housing. Do not use abrasive cleaners, waxes or solvents to clean the device.
- See the device enclosure for safety related markings.
- The device should only be repaired by appropriate service personnel.

Copyright

This publication, including all photographs, illustrations and software, is protected under international copyright laws, with all rights reserved. Neither this manual, nor any of the material contained herein, may be reproduced without written consent of the author.

© Copyright 2020

Disclaimer

The information in this document is subject to change without notice. The manufacturer makes no representations or warranties with respect to the contents hereof and specifically disclaims any implied warranties of merchantability or fitness for any particular purpose. The manufacturer reserves the right to revise this publication and to make changes from time to time in the content hereof without obligation of the manufacturer to notify any person of such revision or changes.

Trademark Recognition

Kensington is a U.S. registered trademark of ACCO Brand Corporation with issued registrations and pending applications in other countries throughout the world.

HDMI, the HDMI Logo, and High-Definition Multimedia Interface are trademarks or registered trademarks of HDMI Licensing LLC in the United States and other countries.

Google, the Google logo, and Google Drive are trademarks or registered trademarks of Google LLC.

OneDrive is a trademark and brand of Microsoft Corporation.

All other product names used in this manual are the properties of their respective owners and are Acknowledged.

FCC Statement

This equipment has been tested and found to comply with the limits for a Class B digital device, pursuant to part 15 of the FCC Rules. These limits are designed to provide reasonable protection against harmful interference in a residential installation.

This equipment generates, uses and can radiate radio frequency energy and, if not installed and used in accordance with the instructions, may cause harmful interference to radio communications. However, there is no guarantee that interference will not occur in a particular installation. If this equipment does cause harmful interference to radio or television reception, which can be determined by turning the equipment off and on, the user is encouraged to try to correct the interference by one or more of the following measures:

- Reorient or relocate the receiving antenna.
- Increase the separation between the equipment and receiver.
- Connect the equipment into an outlet on a circuit different from that to which the receiver is connected.
- Consult the dealer or an experienced radio/TV technician for help.

FCC Warning

This device complies with Part 15 of the FCC Rules. Operation is subject to the following two conditions:

- (1) this device may not cause harmful interference, and
- (2) this device must accept any interference received, including interference that may cause undesired operation.

Notice: Canadian users

This Class B digital apparatus complies with Canadian CAN ICES-3 (B)/NMB-3 (B).

Remarque à l'intention des utilisateurs canadiens

Cet appareil numérique de la classe B est conforme à la norme NMB-003 du Canada.

Declaration of Conformity for EU Countries

- EMC Directive 2014/30/EU (Including amendments)
- Low Voltage Directive 2014/35/EU

WEEE



Disposal instructions

Do not throw this electronic device into the trash when discarding. To minimize pollution and ensure utmost protection of the global environment, please recycle it.

ENERGY STAR



ENERGY STAR is a U.S. Environmental Protection Agency voluntary program that helps businesses and individuals save money and protect our climate through superior energy efficiency. Products that earn the ENERGY STAR prevent greenhouse gas emissions by meeting strict energy efficiency criteria or requirements set by the U.S. Environmental Protection Agency. The following logo appears on all ENERGY STAR-certified models:

This product qualifies for ENERGY STAR in the “Presentation mode” setting and this is the setting in which power savings will be achieved. Changing the Standard mode picture settings or enabling other features will increase power consumption that could exceed the limits necessary to qualify for ENERGY STAR rating. Refer to EnergyStar.gov for more information on Energy Star program.

INTRODUCTION

Package Contents

Carefully unpack and verify that you have the items listed below under standard accessories. Some of the items under optional accessories may not be available depending on the model, specification and your region of purchase. Please verify with your place of purchase. Some accessories may vary from region to region.

The warranty card is only supplied in some specific regions. Please consult your dealer for detailed information.

Standard Accessories

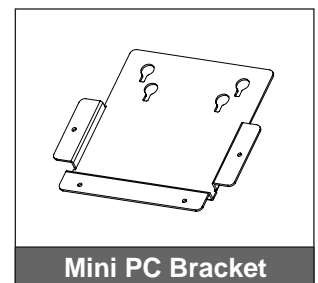
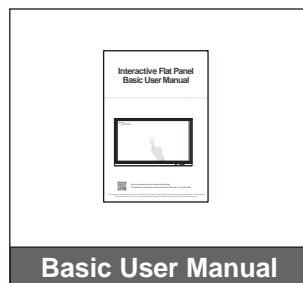
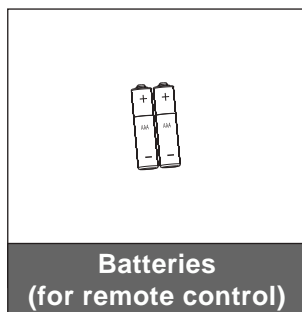
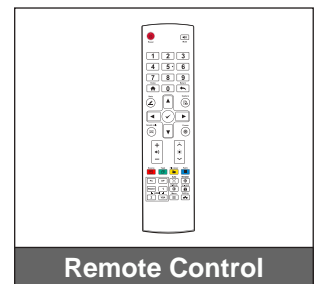
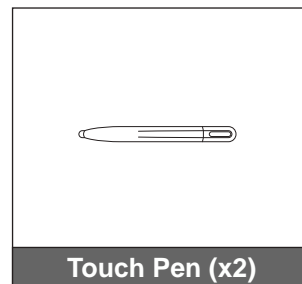
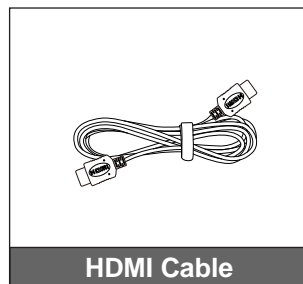
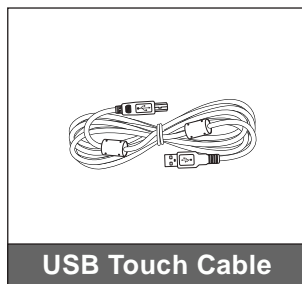
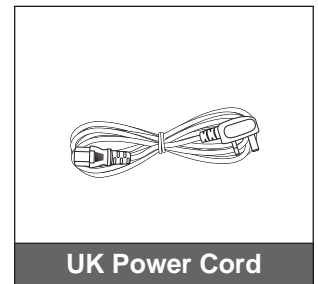
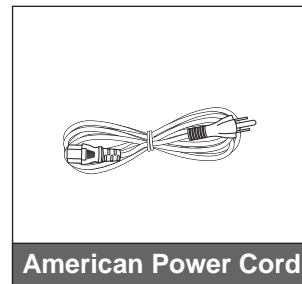
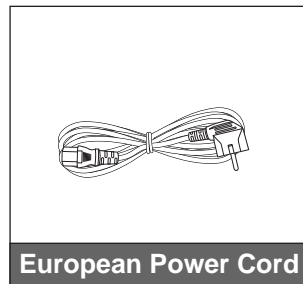
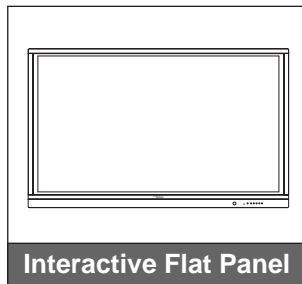

Note: For warranty information, please visit www.optoma.com.

INTRODUCTION

Optional Accessories

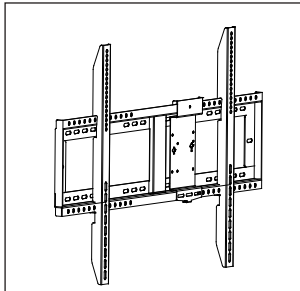

Wall Mount with
PC Vesa Bracket
(OWMFP01)

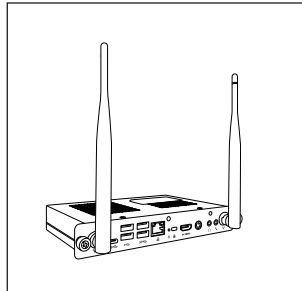

OPS2-i5 (slot in PC,
intel i5 8th CPU, 8G
RAM, 128G SSD)

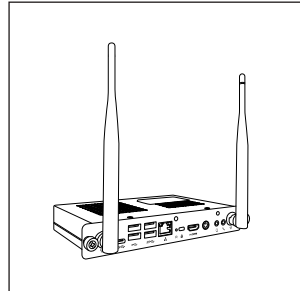

OPS2-i7 (slot in PC,
intel i7 8th CPU, 8G
RAM, 256G SSD)

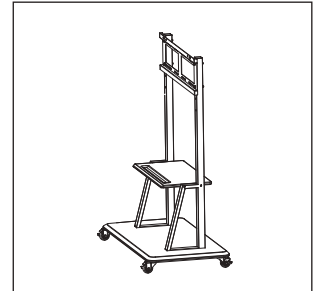

Stand Mount

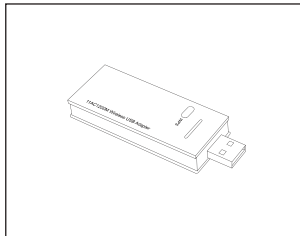

Wi-Fi Dongle

INTRODUCTION

Product Overview

Front View

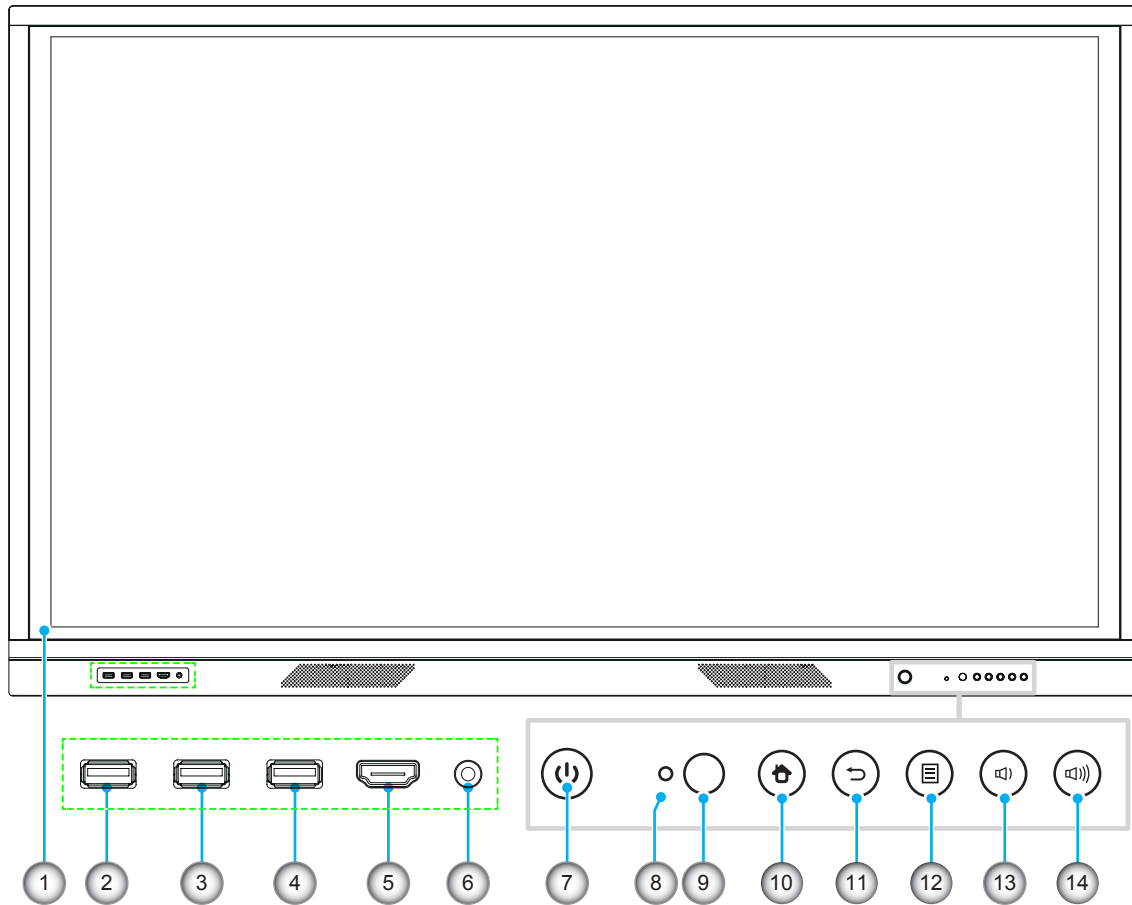

No.	Item
1.	Touch screen
2.	USB 2.0
3.	USB 2.0
4.	USB TOUCH
5.	HDMI Front
6.	MIC in
7.	Power button with LED indicator

No.	Item
8.	Light sensor
9.	IR receiver
10.	Home button
11.	Back button
12.	Setup menu button
13.	Decrease volume button
14.	Increase volume button

Note: Front USB 2.0 ports are full channel USB ports. USB ports can be used irrespective of the chosen input source.

INTRODUCTION

Rear View

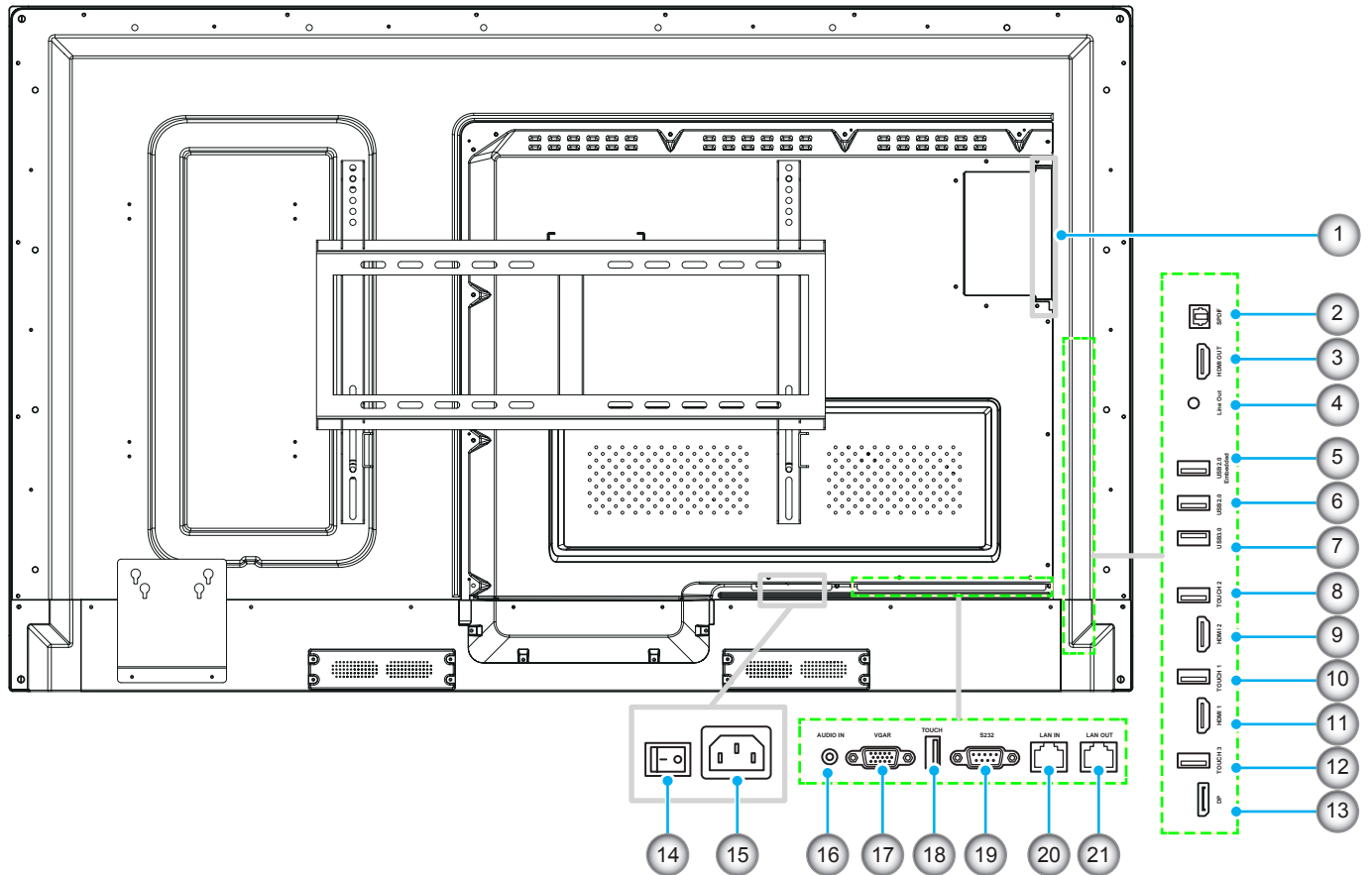

No.	Item
1.	OPS slot
2.	SPDIF
3.	HDMI Out
4.	Line Out
5.	USB 2.0 Embedded
6.	USB 2.0
7.	USB 3.0
8.	Touch 2
9.	HDMI 2
10.	Touch 1
11.	HDMI 1

No.	Item
12.	Touch DP
13.	DP
14.	Power switch
15.	AC In socket
16.	Audio In
17.	VGA
18.	Touch
19.	RS232
20.	LAN IN
21.	LAN OUT

Note: Side USB 3.0 ports are full channel USB ports. USB ports can be used irrespective of the chosen input source.





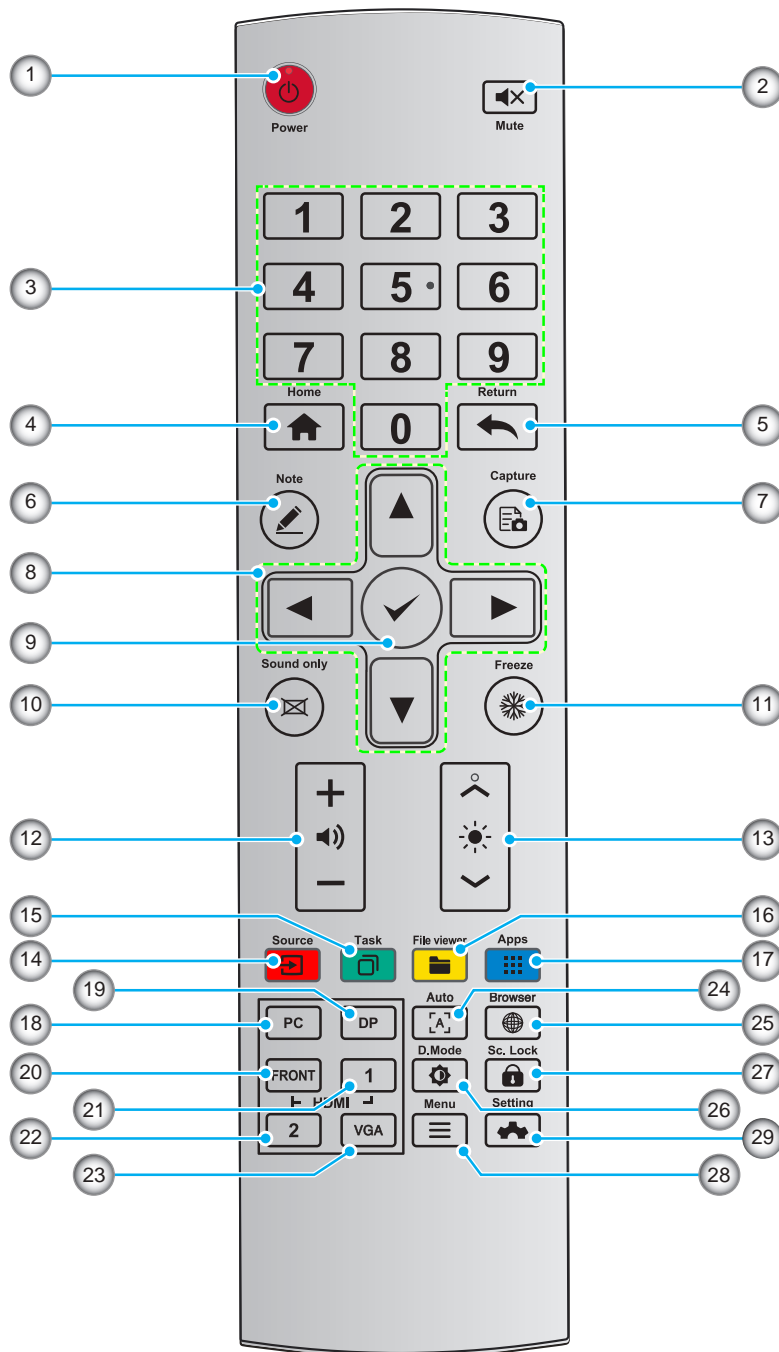











INTRODUCTION

Remote Control



No.	Button	Description
1.		Power On/Off
2.		Mute/Unmute
3.	0-9	Enter Number
4.		Go to the Home Page
5.		Return to Previous/Exit
6.		Enter Whiteboard Mode

INTRODUCTION

No.	Button	Description
7.		Take a Screenshot
8.		Up/Down/Left/Right
9.		Confirm/OK
10.		Enable Sound Only Mode
11.		Freeze the Current Screen, Click Again to Exit Freeze Function
12.		Adjust the Sound Volume
13.		Adjust the Brightness (10 to 255)
14.		Enter the Source Selection Page
15.		View Currently Running Applications
16.		Open the File Manager
17.		View all Pre-installed Applications
18.	PC	Switch Source to Internal PC
19.	DP	Switch Source to Display Port
20.	HDMI FRONT	Switch Source to HDMI Front
21.	HDMI 1	Switch Source to HDMI 1
22.	HDMI 2	Switch Source to HDMI 2
23.	HDMI VGA	Switch Source to VGA
24.		Autocorrection Screen Display (For VGA Signal Source)
25.		Open the Browser Application
26.		Toggle Display Backlight Mode
27.		Start/Exit the Screen Lock Function
28.		Open the External Source Menu
29.		Open the System Settings

Note: If the PC module is not installed into the OPS slot, all computer-related keys will have no function.

SETUP AND INSTALLATION

Wall Mounting Installation

Use only an Optoma-approved optional wall mount kit (available separately). Kit will include the following items:

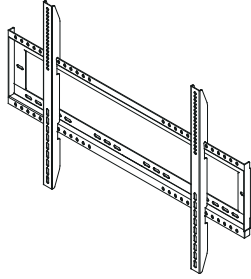

Dual mounting brackets and wall mount



Screw A (x4)



Screw B (x8)



Screw C (x2)



Anchor (x8)



Washer (x8)

Wall Mount Specifications

Model Name	VESA Grid	Screw Type & Length
65-inch	600 x 400 mm	M8*25L
75-inch	800 x 400 mm	M8*25L
86-inch	800 x 400 mm	M8*25L

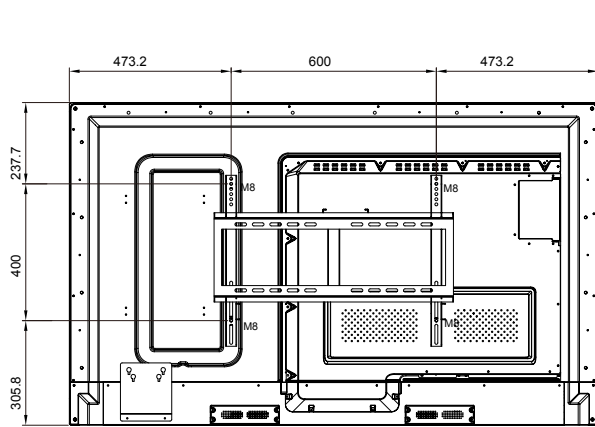

65-inch

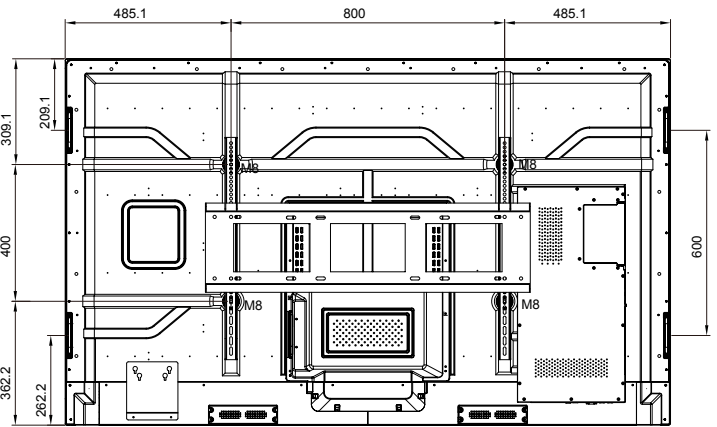

75-inch

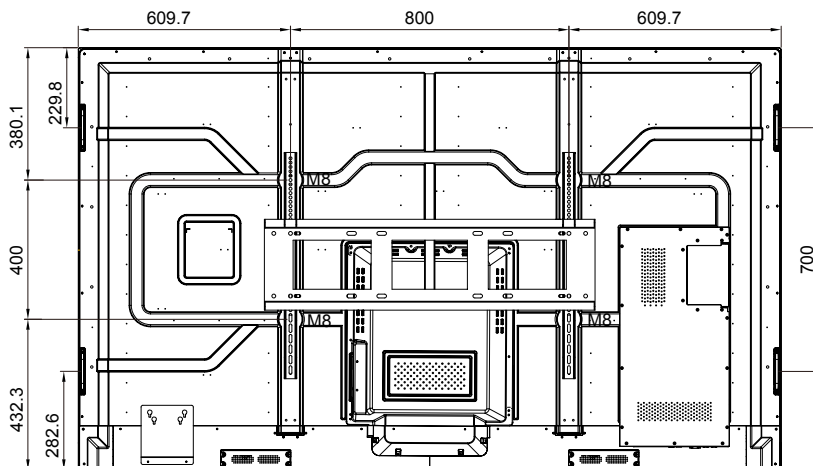

86-inch

SETUP AND INSTALLATION

To mount the IFP on the wall, complete the following steps:

1. Install the dual mounting brackets on the rear of the IFP. Then secure the brackets with four screws (A).

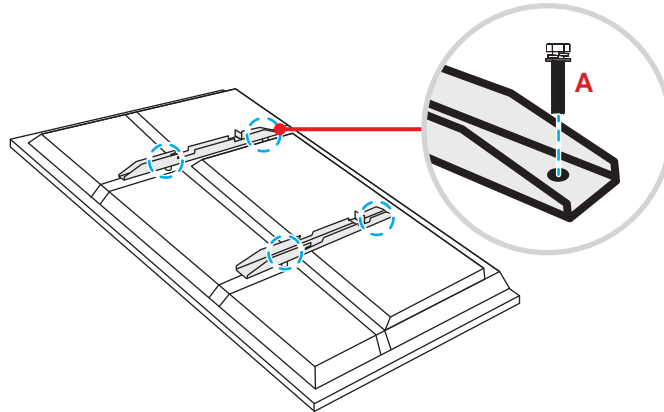

2. Drill eight small holes on the mounting location and insert the anchors into the holes.

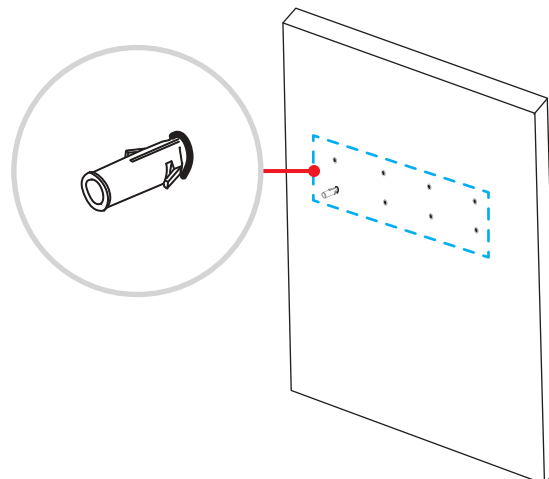

3. Position the wall mount on the wall, then secure the wall mount with eight screws (B) through the washers into the installed anchors on the wall.

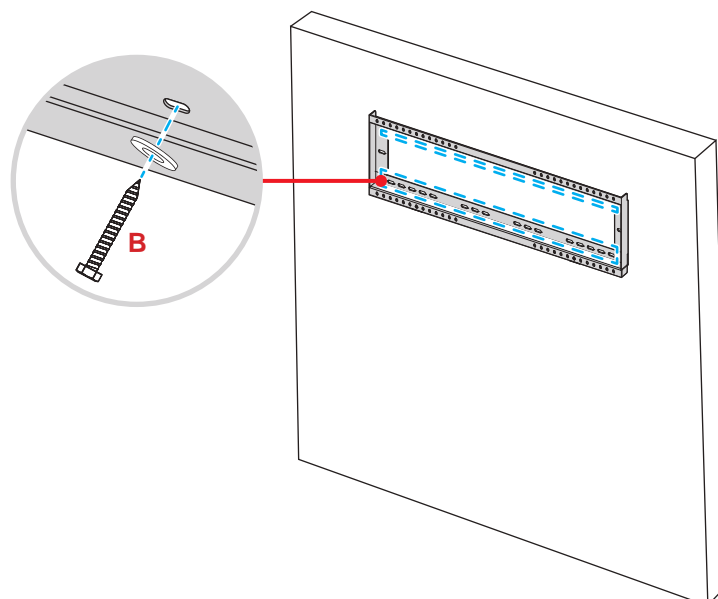

SETUP AND INSTALLATION

4. Align and hook the dual mounting brackets to the wall mount.

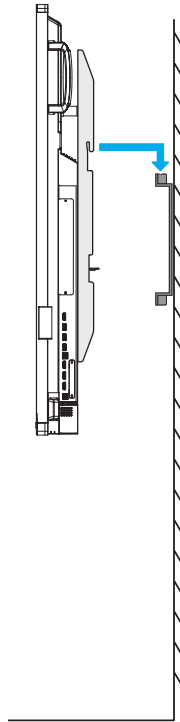

5. Secure the dual mounting brackets and the wall mount with two screws (C).

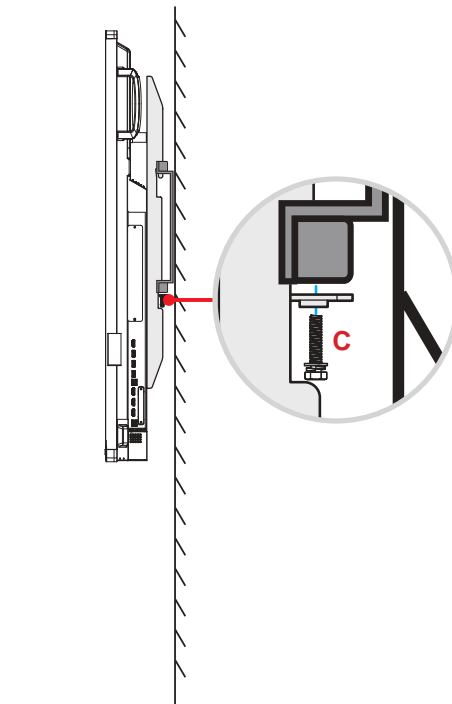

Note:

- *The maximum wall mount kit load capacity: 160kg (352lbs).*
- *Please ensure that the wall mount is installed on a wall that can bear the weight of the IFP. If an appropriate wall is not available, we recommend using a stand instead. Please refer to page 18.*
- *Screws must be tightly secured; however, to avoid damage to the mounting brackets, wall mount, or IFP, do not overtighten the screws.*
- *The installation should only be performed by qualified technicians. Improper installation may cause the IFP to fall or malfunction.*

SETUP AND INSTALLATION

Installing an External Mini Computer

Install the mini PC bracket on the rear side of the IFP, then complete one of the following to install the mini computer:

- Install the screws onto the mini computer, then align and hook the mini computer to the mini PC bracket.
- Align and install the mini computer to the mini PC bracket. Then secure it with four screws.

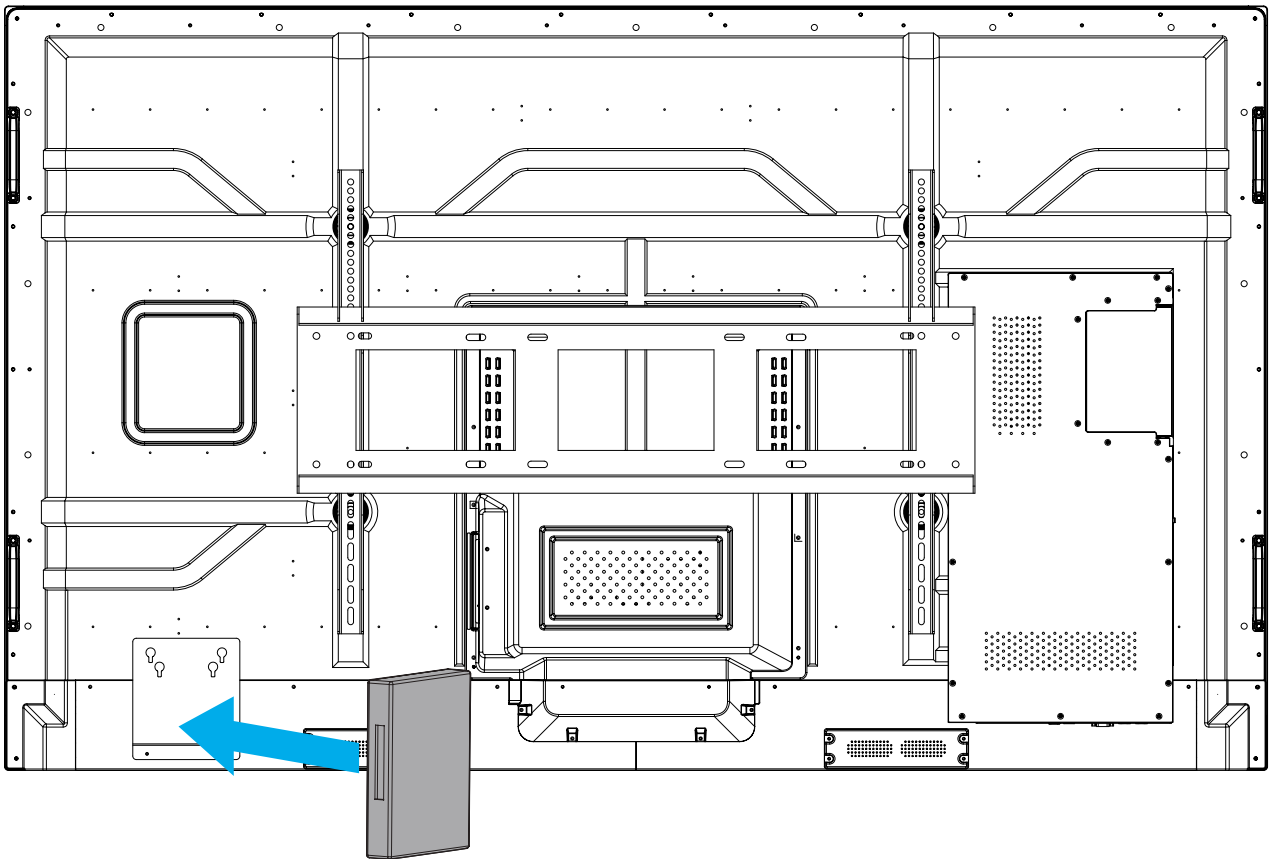

SETUP AND INSTALLATION

Stand Mounting Installation (Optional)

The stand mount kit includes the following items:

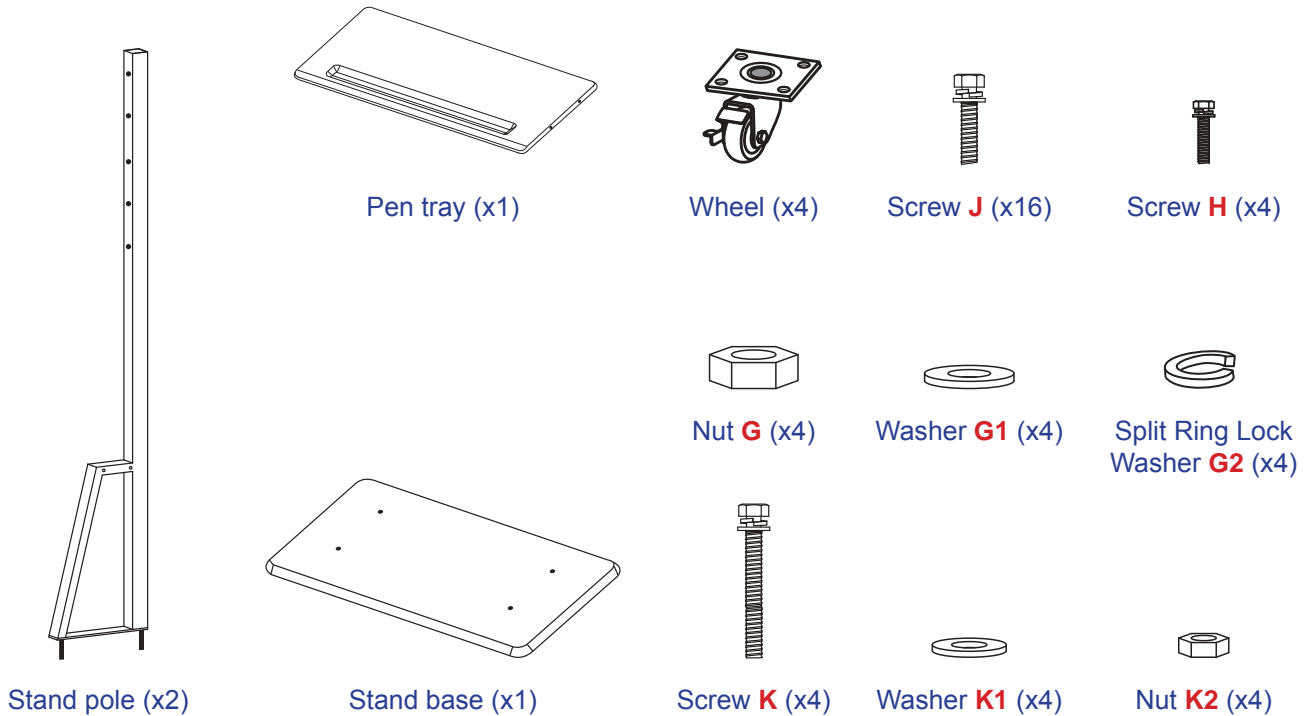

To mount the IFP on the stand, complete the following steps:

1. Install the dual mounting brackets on the rear of the IFP. Then secure the brackets with four screws (A).

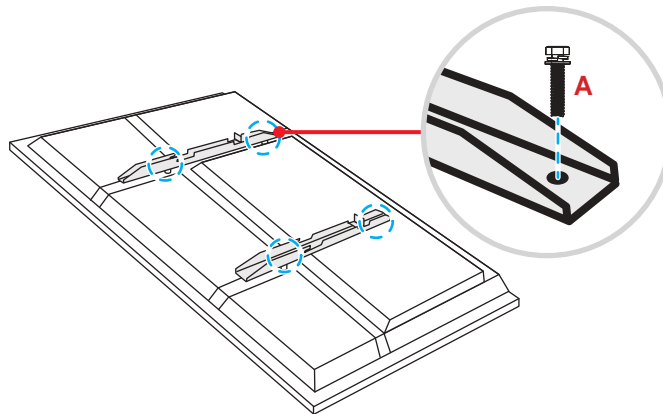

Note: Dual mounting brackets, wall mount, and screws (A) are included in the wall mount kit. Refer to “Wall Mounting Installation” on page 14.

SETUP AND INSTALLATION

2. Flip the stand base so that you can see the screw holes for the wheel, then install the wheel onto its slot and secure it with four screws (**J**).
Repeat the same procedure to install the remaining three wheels.

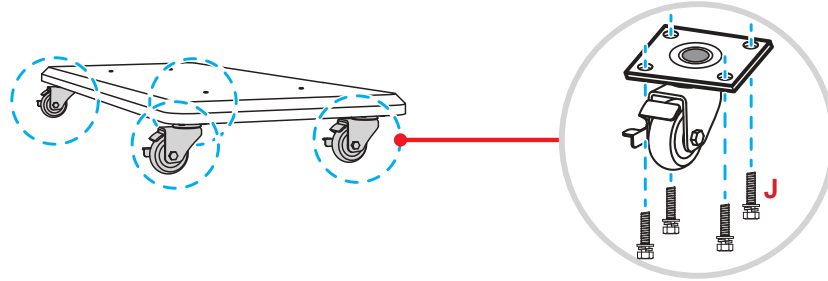

3. Place the stand base on the stable surface, then install the stand pole onto its slot and secure both standoffs with two nuts (**G**) through the washers (**G2** and **G1**).
Repeat the same procedure to install another stand pole.

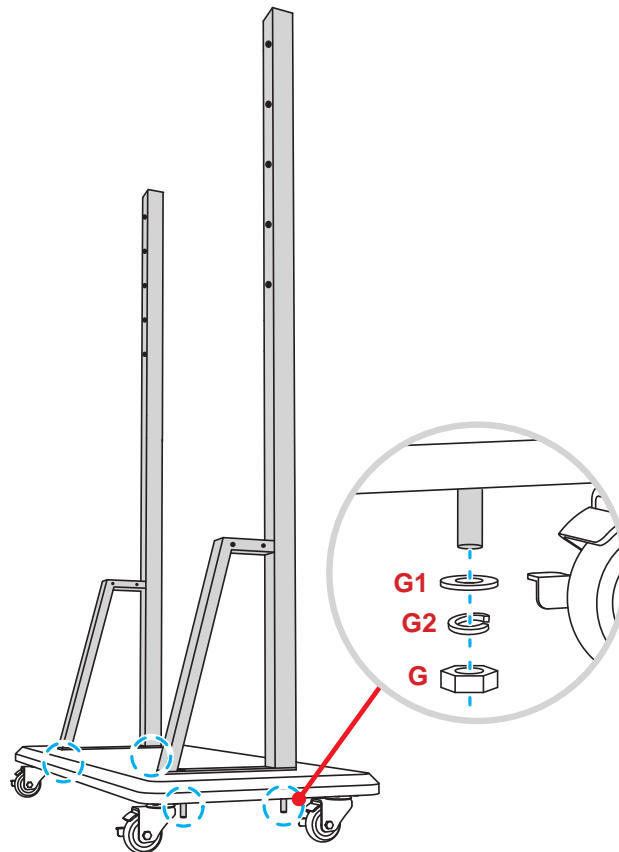

SETUP AND INSTALLATION

4. Align the pen tray with the screw holes on the middle part of the poles, then secure the pen tray with four screws (**H**).
5. Install the wall mount on the upper part of the poles, then insert the screws (**K**) through the screw holes from the rear side of the poles.
6. Place the washers (**K1**) and the nuts (**K2**) into the screws, then tighten the nuts (**K2**) to secure the wall mount in place.

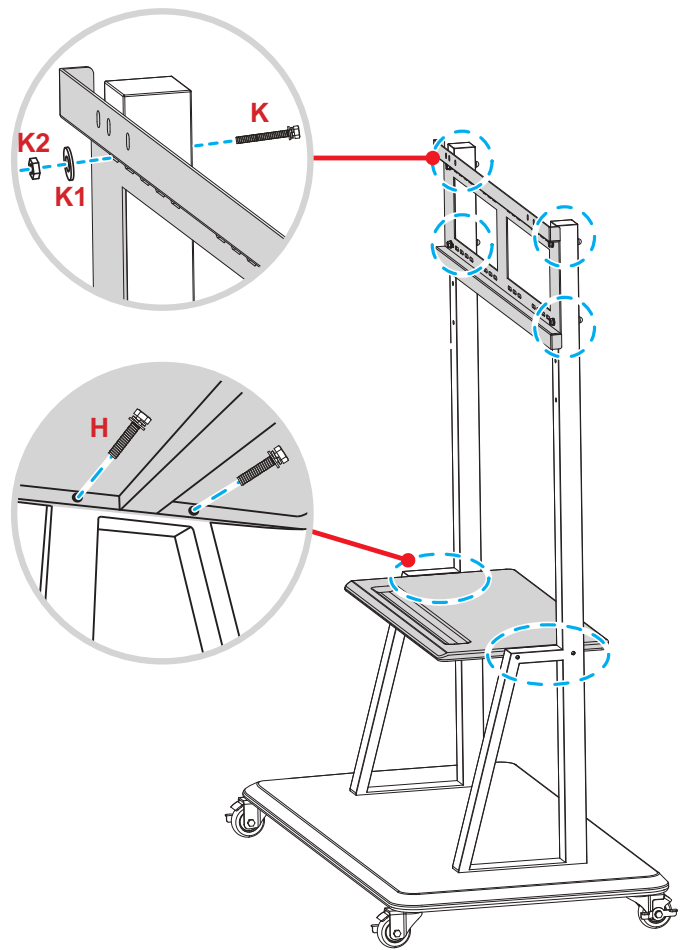

7. Align and hook the dual mounting brackets to the installed wall mount on the stand poles.

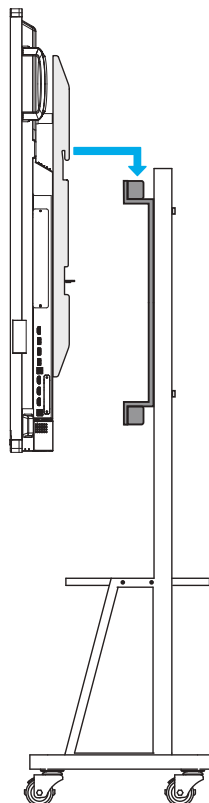

SETUP AND INSTALLATION

Using the Remote Control

Installing/Replacing the Remote Control Batteries

Two AAA size batteries are supplied for the remote control.

IMPORTANT! Replace only with the same or equivalent type batteries.

1. Remove the cover of the battery compartment.

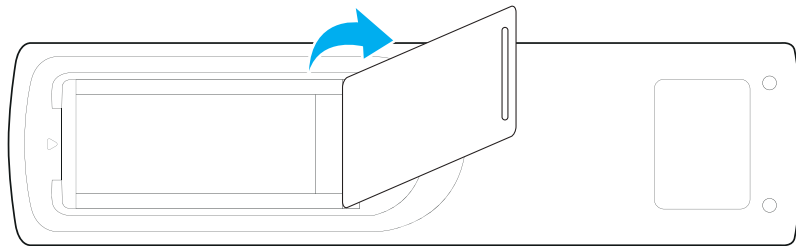

2. Insert the two batteries with correct polarity (+/-) as shown inside the battery compartment.

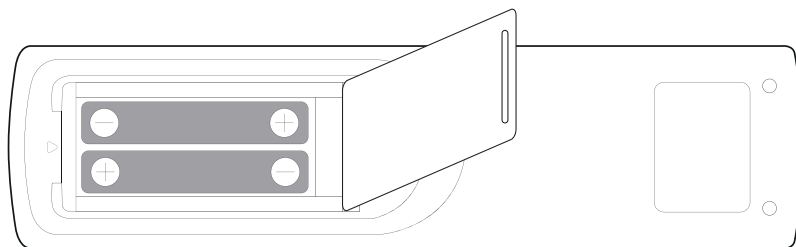

3. Replace the cover.

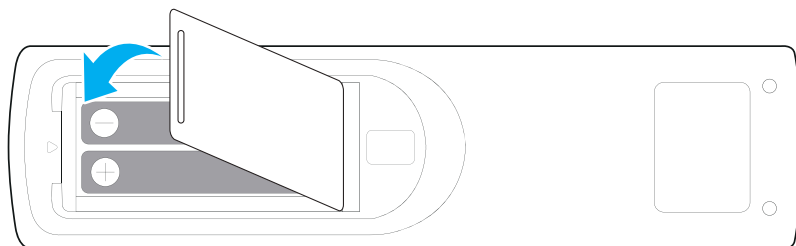

CAUTION

Improper use of batteries can result in chemical leakage or explosion. Be sure to follow the instructions below.

- Do not mix batteries of different types. Different types of batteries have different characteristics.
- Do not mix old and new batteries. Mixing old and new batteries can shorten the life of new batteries or cause chemical leakage in old batteries.
- Remove batteries as soon as they are depleted. Chemicals that leak from batteries that come in contact with skin can cause a rash. If you find any chemical leakage, wipe thoroughly with a cloth.
- The batteries supplied with this product may have a shorter life expectancy due to storage conditions.
- If you will not be using the remote control for an extended period of time, remove the batteries.
- When you dispose of the batteries, you must follow the guidelines in your relative area or country.

SETUP AND INSTALLATION

Remote Control Operating Range

When using the remote control, make sure to point it within $\pm 30^\circ$ to the IR receiver on the IFP. The distance between the remote control and the IR sensor window should not be longer than 8 meters.

- Make sure that there are no obstacles between the remote control and the IR sensor window on the IFP that might obstruct the infra-red beam.
- Make sure the IR transmitter of the remote control is not being used in sunlight or fluorescent lamps directly.
- If the remote control is closed to Inverter-Type fluorescent lamps, it might become ineffective from time to time.
- If the remote control and the IFP are within a very short distance, the remote control might become ineffective.

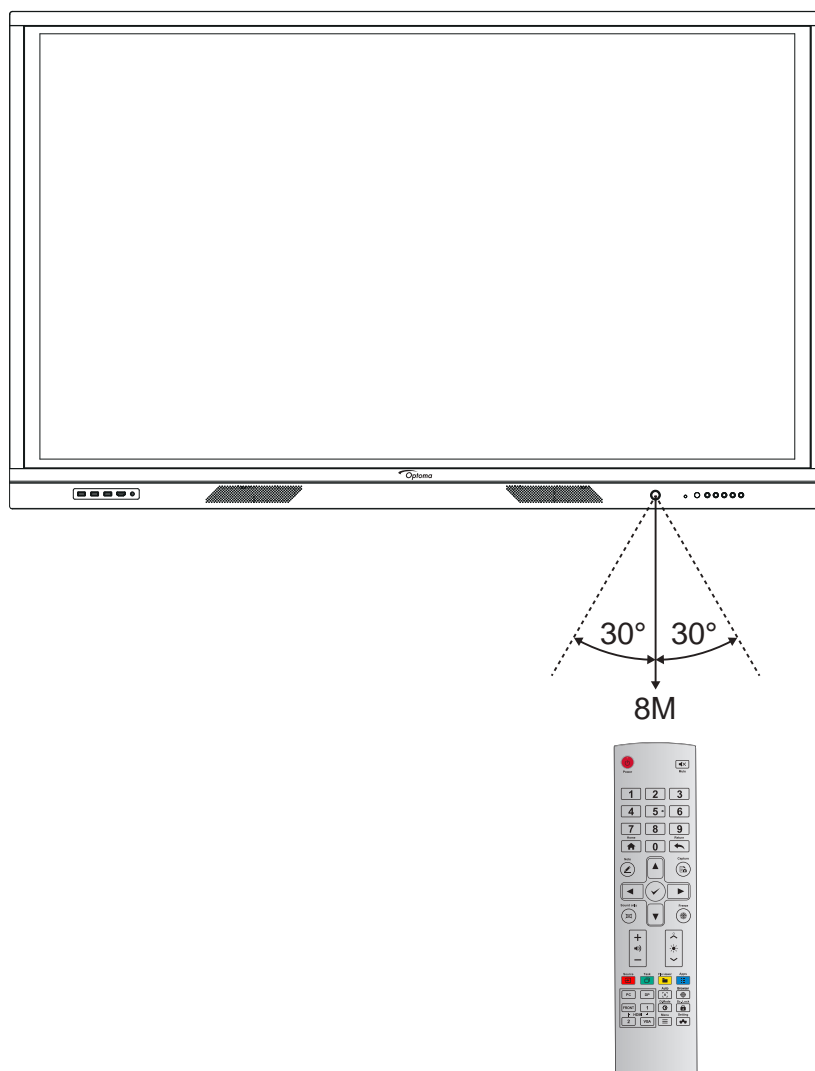

SETUP AND INSTALLATION

Connections

Connecting to Power

1. Connect one end of the power cord to the AC-in socket on the IFP.
2. Connect the other end of the power cord to a power outlet or a power supply.
3. Set the **Power** switch to ON (I). The IFP will automatically enter standby mode.



Connecting External Devices

IMPORTANT! To use the touch screen function, make sure to connect one end of the USB cable to the USB B port on the IFP and the other end of the cable to the USB A port on your device.

HDMI input connection

- Connect your computer to the IFP using an HDMI cable.

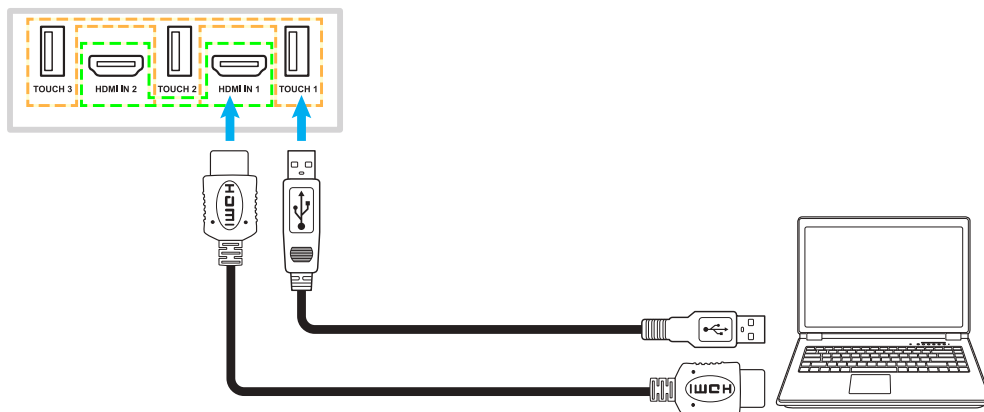

- Connect your video source to the IFP using an HDMI cable.

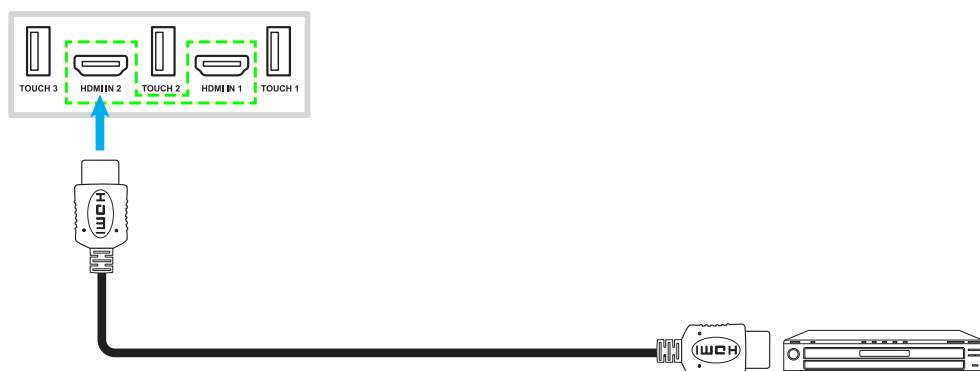

SETUP AND INSTALLATION

VGA input connection

Connect your computer to the IFP using a VGA cable.

Note: For audio input, connect one end of an audio cable to the Audio-in jack on the IFP and the other end of the cable to the audio jack on your computer.

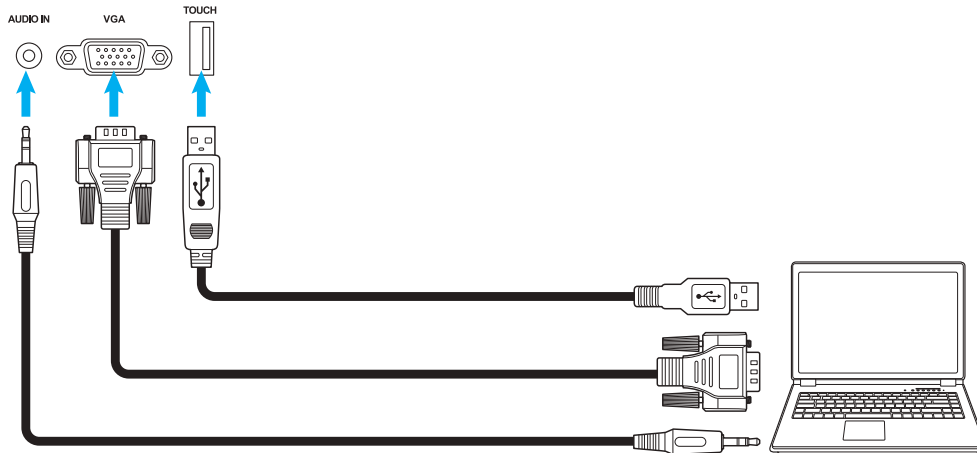

Audio output connection

Connect your external speakers to the Audio-out port on the IFP.



SPDIF connection

Connect your audio equipment to the IFP using a SPDIF cable.

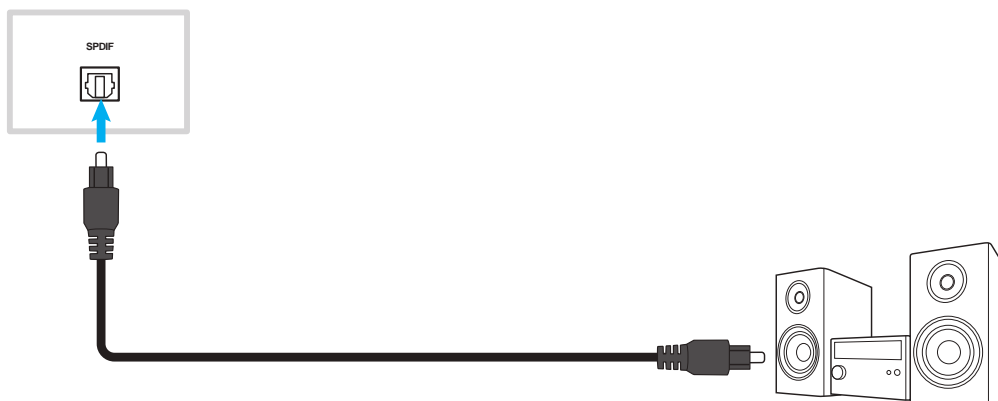

SETUP AND INSTALLATION

HDMI output connection

Connect your projector to the HDMI out port on the IFP.

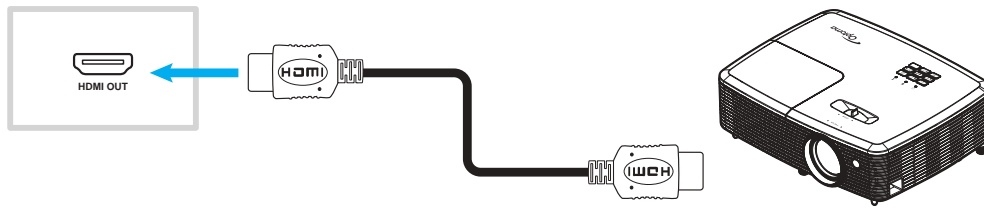

USB connection

Connect your USB peripheral device to the IFP using a USB cable.

Note: For the USB flash drive connection, simply plug it into one of the available USB ports.

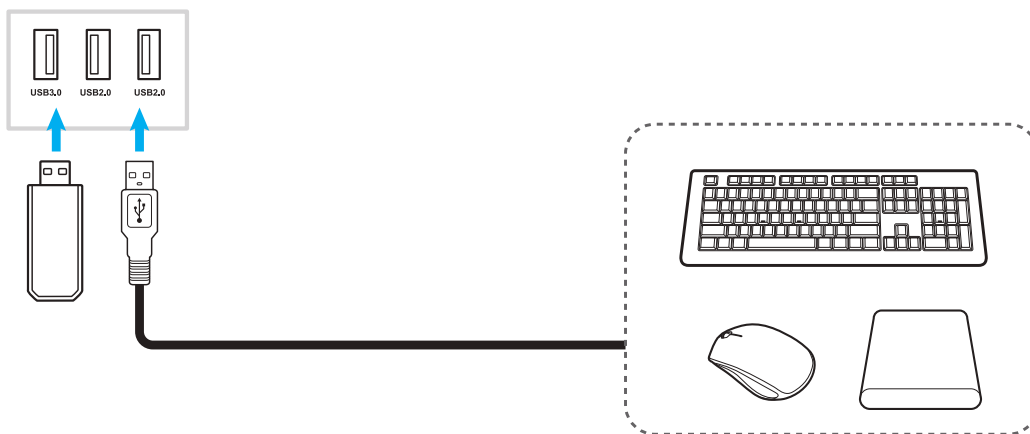

RS232 connection

Connect your computer to the IFP using a RS232 cable.



Display connection

Connect your mini PC to the IFP using a Display cable.



SETUP AND INSTALLATION

LAN connection

Connect your router to the IFP using an Ethernet cable.



Note: To configure network settings, refer to “Configuring Network Settings” on page 41.

Wi-Fi connection

For Wi-Fi connection, you need to install a Wi-Fi dongle to the USB port slot on the side of the IFP. Wi-Fi dongle can receive the signal in an area where there is a Wi-Fi network.

To install the Wi-Fi dongle, complete the following steps:

Plug WIFI USB dongle into USB 2.0 Embedded port, it can receive the signal in the area where there is WIFI network.

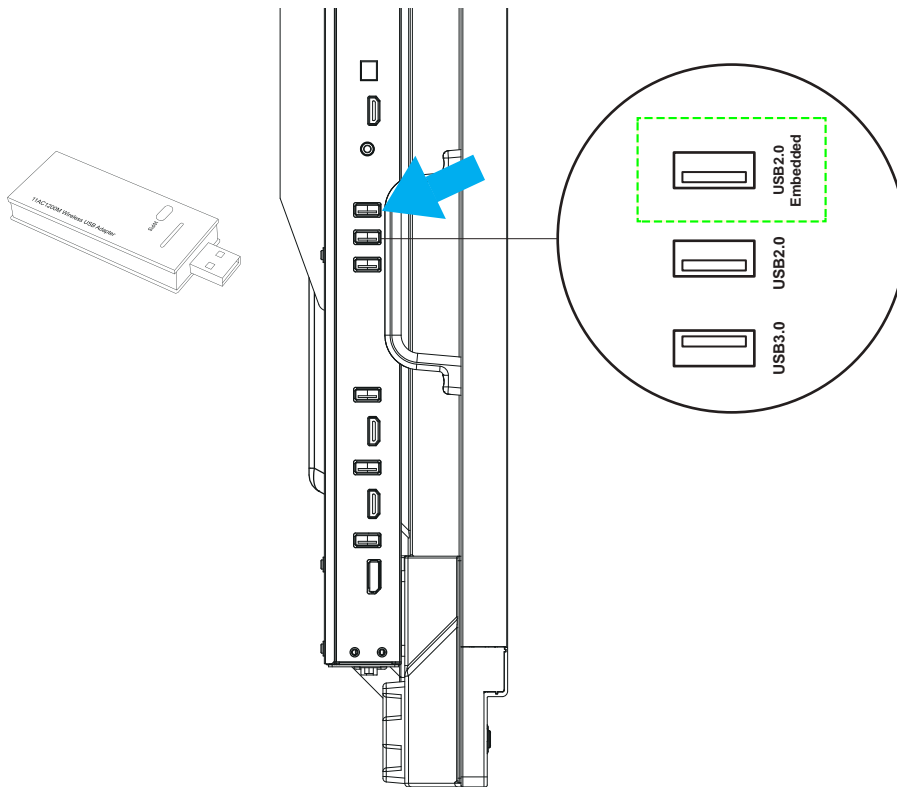

Note: To configure Wi-Fi settings, refer to “Configuring Network Settings” on page 41.

SETUP AND INSTALLATION

Touch pen holder connection

To install a holder for the touch pen, complete the following steps:

1. Attach the magnetic touch pen holder to the front side of the screen.

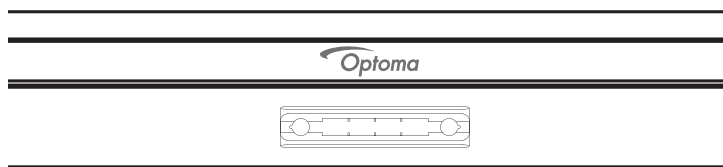

2. Insert the touch pen to its holder.

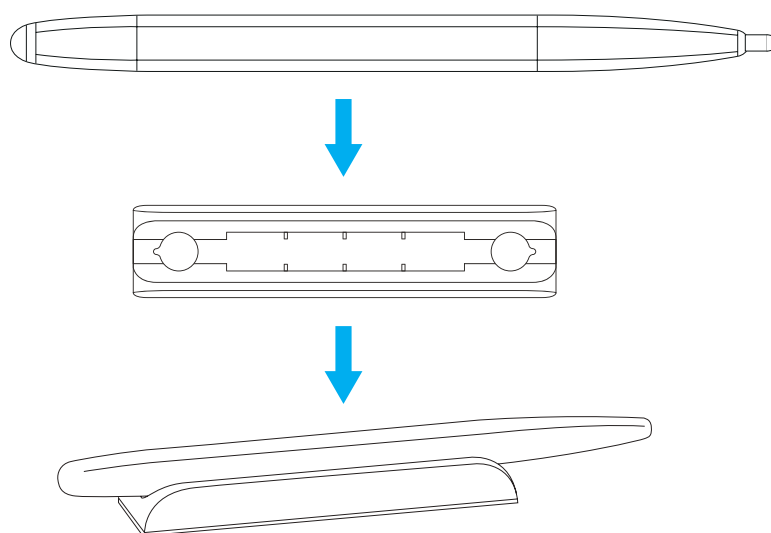

USING THE DEVICE

Turning the Power On/Off

Powering on

Note: After the power cord is properly connected, make sure the **Power** switch is set to ON (I).



Press the **Power** button to turn on the IFP. The LED indicator light turns white, indicating it is ready to use.

Note: You can also press the  button on the remote control to turn on the IFP.

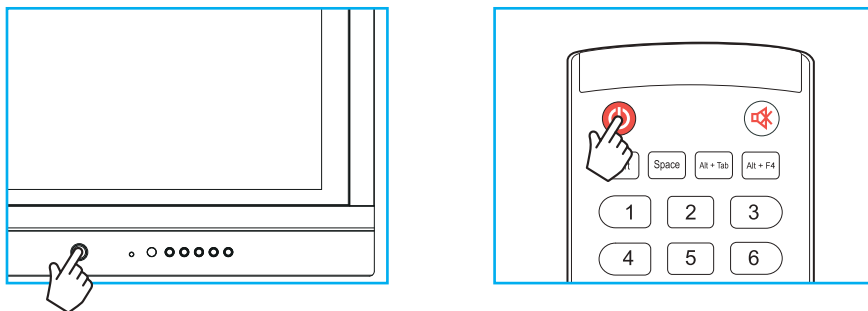

Powering off

Press the **Power** button for 3 seconds to turn off the IFP. Press **OK** at the prompt to turn it off immediately or wait for 10 seconds until the IFP turns off automatically.



When the LED indicator light turns red, this indicates that the IFP has entered standby mode.

Note:

- You can also press the  button on the remote control to turn off the IFP.
- The IFP still consumes power when it is in standby mode. It is highly recommended to unplug the power cord from the power outlet if the IFP will not be used for an extended period of time.

USING THE DEVICE

Setup Wizard

The Setup Wizard will appear on the screen when you turn on your IFP for the first time.

Note: This IFP is equipped with a touch-sensitive screen. You can simply tap the touch screen to operate your IFP.

1. Select the language for the on-screen display (OSD) menu.



2. If you want to connect your IFP to the Internet, select one of the available networks and tap **Connect**. Otherwise, select **Skip**.

IMPORTANT!

- To connect to a wireless network, make sure the Wi-Fi dongle is properly plugged into the USB 2.0 Embedded port. Refer to page 26.
- If you are connecting to a secure network, you will need to enter the password when connecting for the first time only.

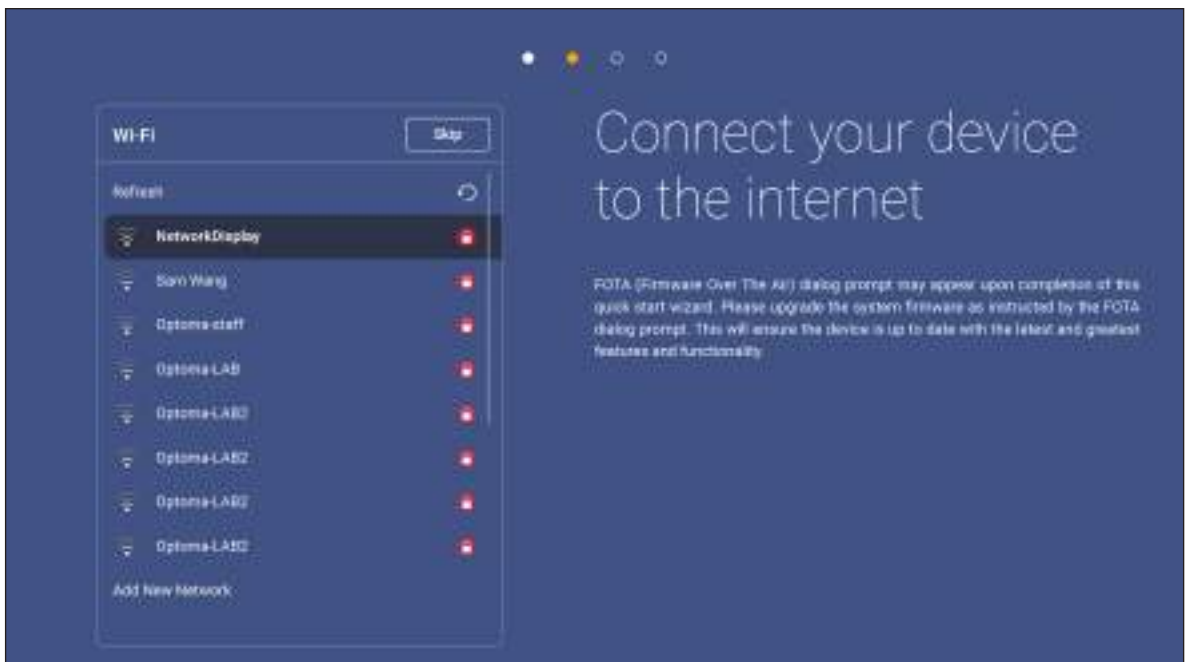

USING THE DEVICE

3. Configure the date and time related settings. Select **Next** to continue.

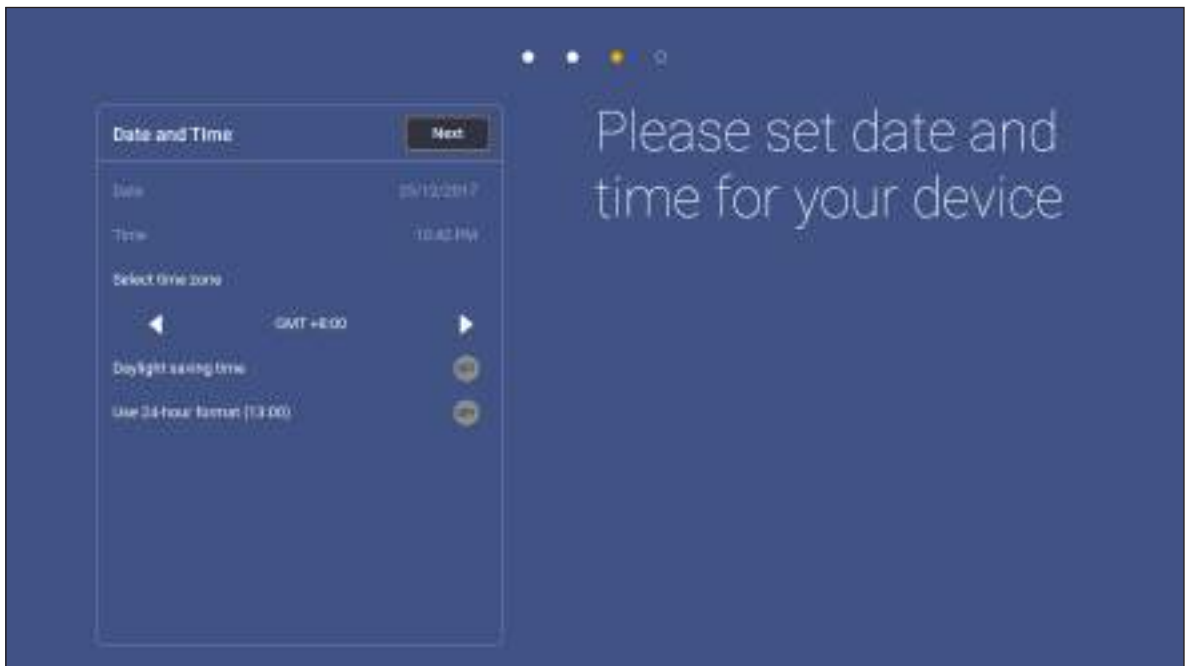

4. Read Optoma's legal policies, including Terms and Conditions of Use, Privacy Policy, and Cookie Policy. Tap **Agree** to complete setup. The IFP is now ready to use.

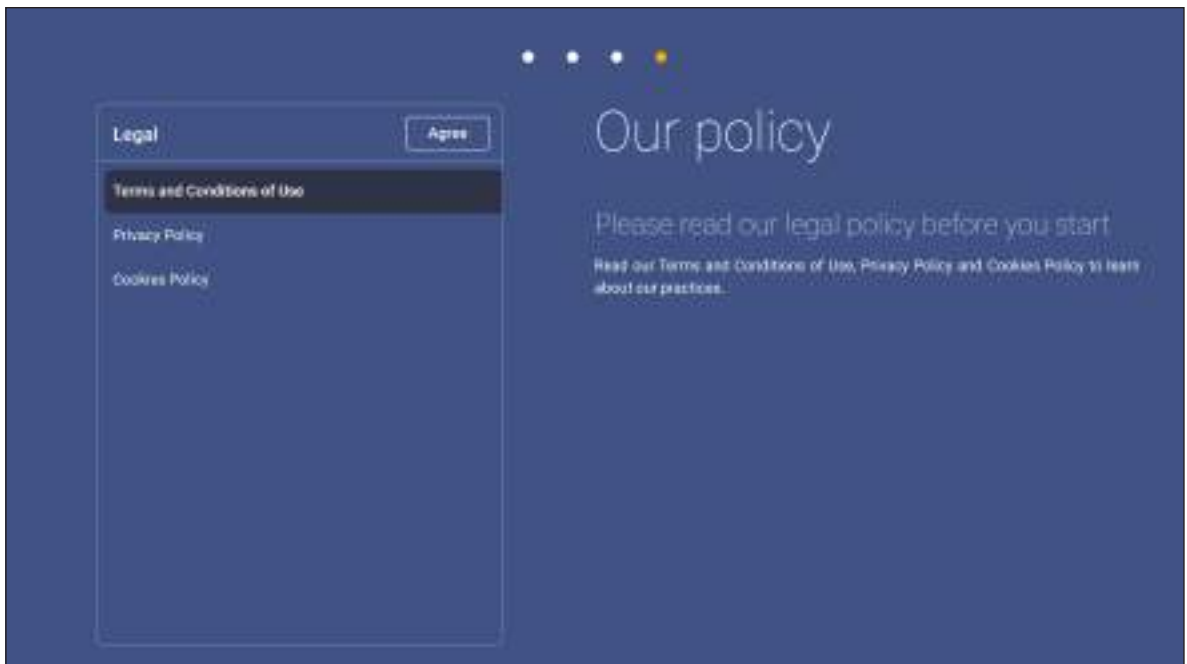



BASIC OPERATIONS

Home Screen Overview

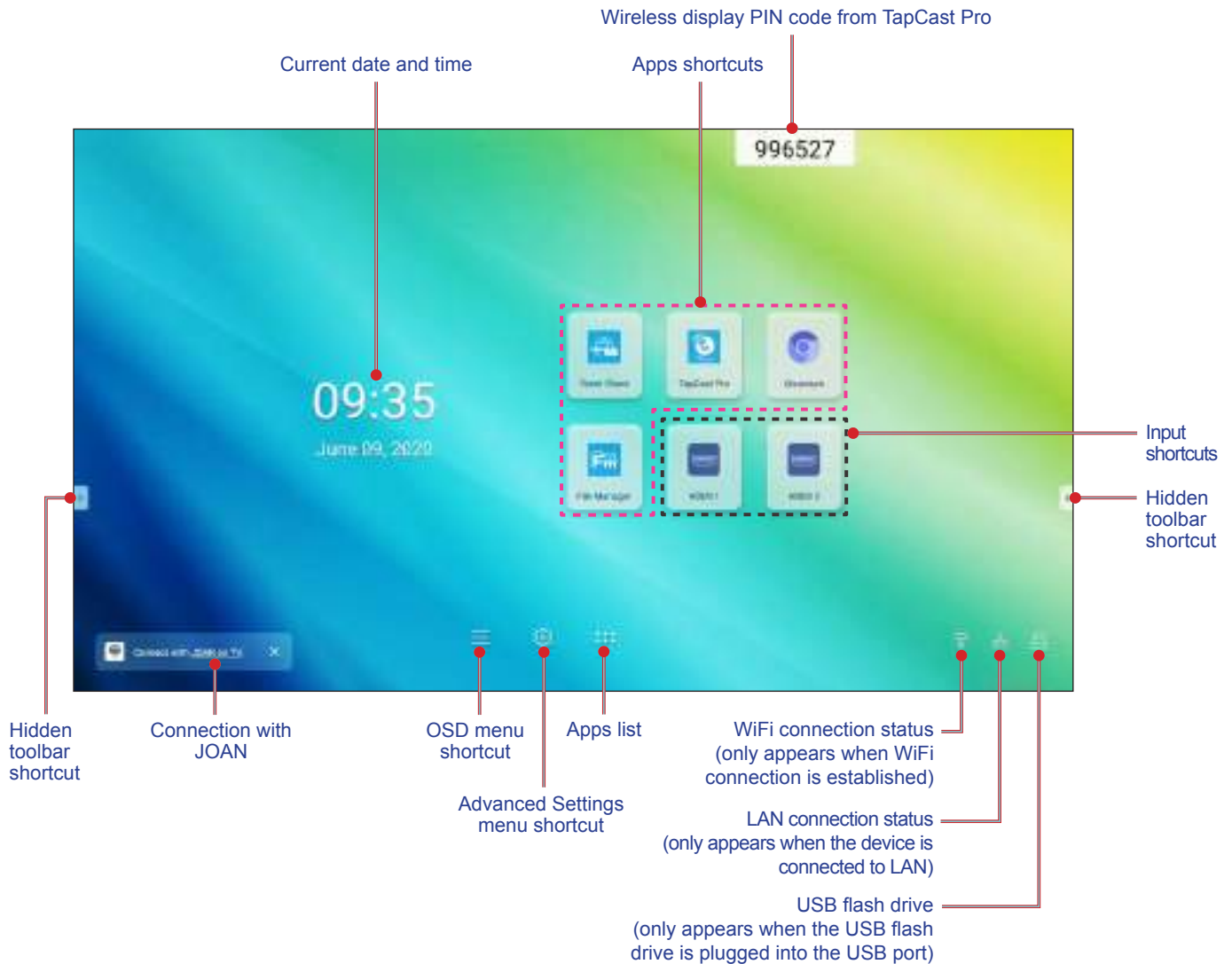
The Home screen is displayed every time you start the IFP.



To navigate the Home screen, you can do the following:

- Select an option: simply tap the desired item.
- Adjust the setting: drag the slider to the left or to the right.
- Open the hidden toolbar: tap  or  on the left/right side of the screen.

Note:

- Unless otherwise specified, this section describes IFP operations using the touch gesture.
- As an alternative, you can also use the remote control to operate the IFP.

BASIC OPERATIONS

Setup Menu

On any screen, drag the bottom of the screen upwards to open the **Setup** menu.



The **Setup** menu is part of the **OSD** menu.

To view other **OSD** menu items, tap  on the left side of the **Setup** menu.



Setup menu



OSD menu

BASIC OPERATIONS

Selecting an Input Source

In the **Setup** menu, the available input source is indicated by the ● icon. To change the input source, simply tap the desired input source.



Note:

- For more information about device connections, refer to the “Connections” section.
- The OPS option is only available if the PC module is properly installed into the OPS slot of the IFP.

Adjusting the Backlight Level

In the **Setup** menu, drag the slider bar to the right/left to adjust the backlight level.

Note: For comfortable viewing experience, you can enable Flicker Free function. Flicker Free option is visible on the screen only if the backlight level is set to 100%.

Note: Flicker Free means the device has no visible and invisible flicker within the range of 0-3000Hz.



BASIC OPERATIONS

Activating the Low Blue Light Function

IMPORTANT! *Studies have shown that just as the ultra-violet rays can cause eye damage, the shortwave-length blue light rays from displays can cause eyestrain, retina damage, and affect vision over time. Optoma Low Blue Light is an eye protection feature that can reduce the blue light.*

In the **Setup** menu, drag the slider bar to the right/left to adjust the low blue light level.



IMPORTANT! *For protecting your eyes against prolonged display use, we highly recommend you to do the following:*

- *Let your eyes rest for 10 minutes after 2 hours of continuous use.*
- *Roll your eyes upward towards your eyebrows, and then roll your eyes in a large circle every few hours.*
- *For every 20 minutes of display viewing, look into the distance for 20 seconds.*
- *When your eyes get sore, close your eyes for a minute.*

Adjusting the Volume Level



In the **Setup** menu, drag the slider bar to the right/left to adjust the volume level.



BASIC OPERATIONS

Configuring OSD Settings

To open the **OSD** menu, do any of the following:

- Drag the bottom of the screen upwards, then tap  on the left side of the **Setup** menu. For more information, refer to “Setup Menu” on page 32.
- Press the **Menu** button on the remote control.
- Tap  on the Home screen.

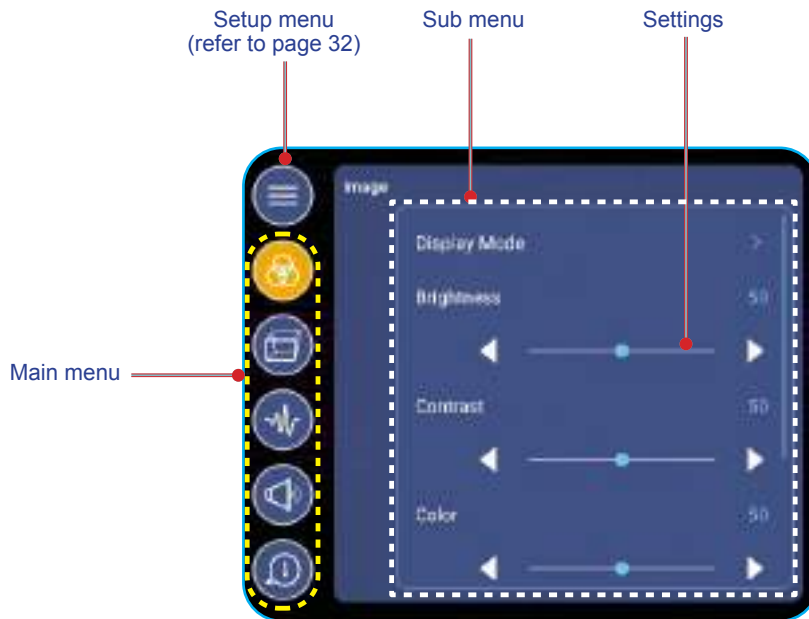

Note:

- To configure **OSD** menu settings, simply touch the desired item on the screen and use screen controls to adjust the value or set the setting.
- To move from sub menu to the main menu, tap **Back**.
- To close the **OSD** menu, tap anywhere on the screen outside the **OSD** menu.

Configuring Image Settings

In **OSD** menu, tap  to open **Image** menu, then complete the following steps:



- Tap **Display Mode** to select one of the available options: Presentation, Bright, Cinema, or User.

BASIC OPERATIONS

Note:

- *USB playback function in Android source also supports HDR content. If you play an HDR video from USB disk, Display Mode will switch to HDR automatically.*
- *Image setting can only be adjusted in HDMI, VGA, and OPS input. It can't be adjusted and will be grayed-out in Android source.*
- *You can customize image settings by adjusting brightness, contrast, color, or color temperature according to your preference. Select **Reset** to reset display mode settings to its defaults.*
- Tap ◀▶ on **Brightness** item to adjust the screen brightness level.
- Tap ◀▶ on **Contrast** item to adjust the screen contrast level.
- Tap ◀▶ on **Color** item to adjust the screen color level from black and white to fully saturated color.
- Tap ◀▶ on **Color Temperature** item to select one of the available options: Standard, Warm, or Cold.
- Tap **Reset** to reset display mode settings to its defaults.

Configuring Display Settings

In **OSD** menu, tap  to open **Display** menu, then complete the following steps:



- Tap **Aspect Ratio** to select one of the available options: 16:9, 4:3, or PTP (Pixel To Pixel).
- Tap ◀▶ on **Pixel Shift (min)** item to select one of the available options: Off, 2, 3, 5, 30, or 60.
Note: *Pixel Shift (min) feature helps to prevent image retention.*
- Tap ◀▶ on **Backlight** item to adjust the backlight level.
Note: *Backlight can be adjusted also in the **Setup** menu. Refer to page 33.*
- Tap ◀▶ on **Low Blue Light** item to adjust the blue light level.
Note: *Low Blue Light can be adjusted also in the **Setup** menu. Refer to “Activating the Low Blue Light Function” on page 34.*
- Tap ◀▶ on **Dynamic Black** item to select one of the available options: Off, Based on Content, or Based on Ambient light.

BASIC OPERATIONS

Configuring Signal Settings (for VGA input only)

In OSD menu, tap  to open **Signal** menu, then complete the following steps:



- Tap **Automatic** to automatically adjust the image to its optimized frequency, phase, and position.
- Tap ◀▶ on **Frequency** item to adjust the vertical noise of the image.
- Tap ◀▶ on **Phase** item to adjust the horizontal noise of the image.
- Tap ◀▶ on **H. Position** item to adjust image horizontal position manually.
- Tap ◀▶ on **V. Position** item to adjust image vertical position manually.

Configuring Audio Settings

In OSD menu, tap  to open **Audio** menu, then complete the following steps:



- Tap ◀▶ on **Sound Effect** item to select one of the available options: Standard, Meeting, Class, Movie, or User.
Note: If the sound effect setting is set to **User**, you can customize audio settings by adjusting the bass and treble level according to your preference.
- Tap **Mute** to mute or unmute audio.
Note: You can also mute or unmute audio by pressing the  button on the remote control.
- Tap ◀▶ on **Volume** item to adjust the volume level.
- Tap ◀▶ on **Bass** item to adjust the bass level that is suitable for your room.
Note: Bass level and Treble level can be adjusted only if the Sound Effect is set to **User**. In other sound effect modes this parameter is preset and cannot be adjusted.

BASIC OPERATIONS

- Tap ◀▶ on **Treble** item to adjust the treble level that is suitable for your room.
- Tap ◀▶ on **Balance** item to adjust the sound balance level that is suitable for your room.

Viewing Device Information

In **OSD** menu, tap  to open the **Information** menu, then complete the following steps:



- Tap **Display** to view display mode, current input source, resolution, color depth, and color format.
- Tap **About Device** to view regulatory model name, serial number, firmware version, and Android version.

BASIC OPERATIONS

Configuring Advanced Settings

To open the **Advanced Settings** menu, tap  on the Home screen.

Note: *Advanced settings can be modified only in Android mode.*

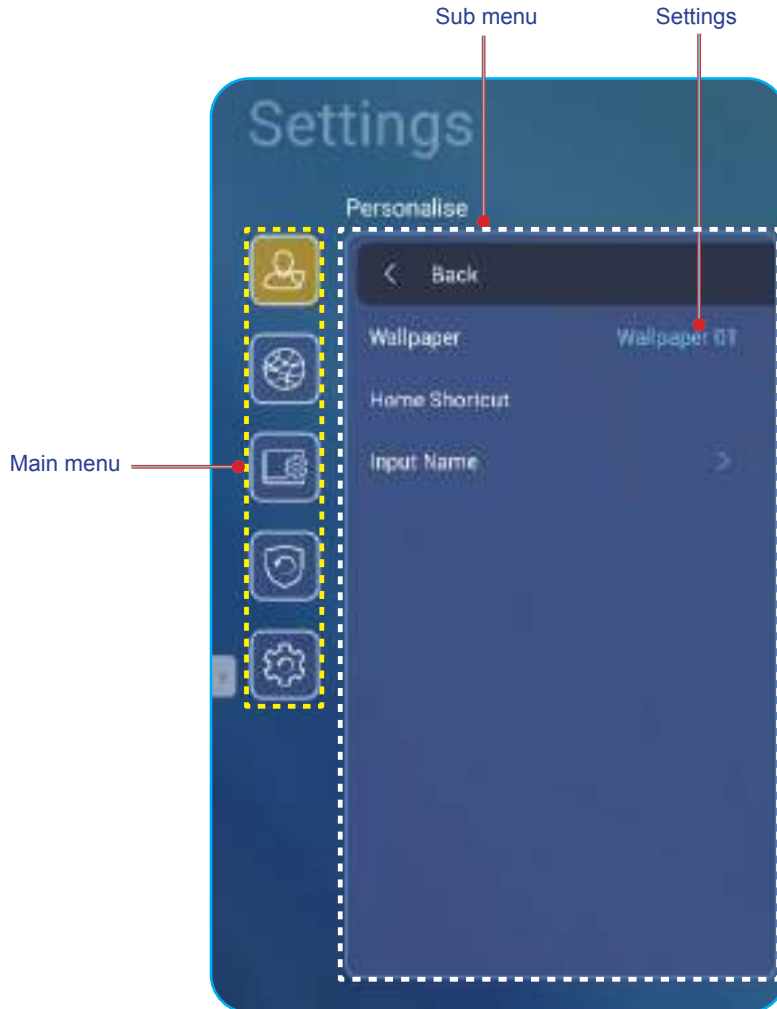

Note:

- To configure **Advanced Settings**, simply touch the desired item on the screen and use screen controls to adjust the value or set the setting.
- To move from sub menu to the main menu, tap **Back**.
- To close the **Advanced Settings** menu, tap anywhere on the screen outside the **Advanced Settings** menu.

BASIC OPERATIONS

Personalizing the System

In the **Advanced Settings** menu, tap  to open **Personalize** menu, then complete the following steps:



- Tap **Wallpaper** and then select one of the available image options among default wallpapers or from an image gallery (**Choose from files**). To confirm the wallpaper, tap **Save** at the prompt.



- Tap **Home Shortcut** to customize Home screen shortcuts. Tap on the shortcut you wish to change. Then select a new shortcut and confirm your selection by tapping **Done** at the prompt.

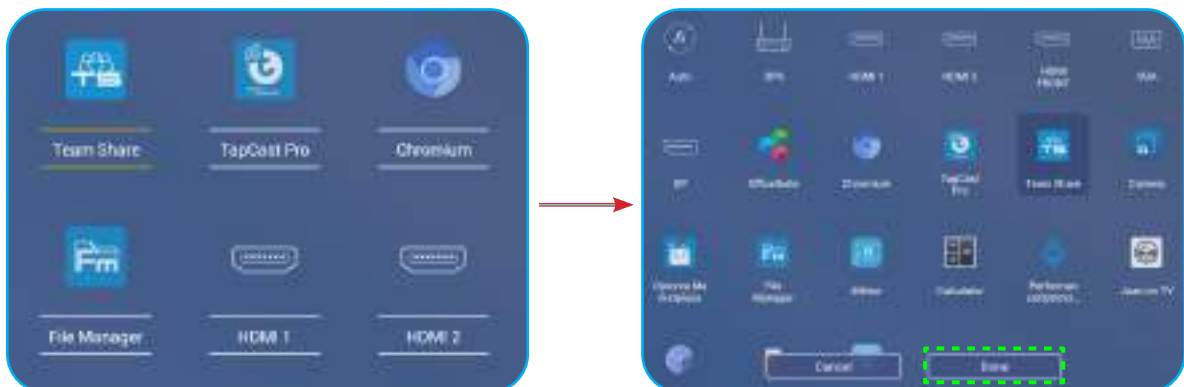

BASIC OPERATIONS

- Tap **Input Name** to rename input. Tap on the input name you wish to change, then type a new name and confirm name modification by tapping **OK** at the prompt.



Configuring Network Settings

In **Advanced Settings** menu, tap  to open **Network** menu, then complete the following steps:



- Tap **Wireless** to connect the IFP to Wi-Fi network and view current connection status. Make sure Wi-Fi function is enabled. In **Available Networks** list, tap on your preferred Wi-Fi network. Provide an access password if needed.
IMPORTANT! *To connect to a wireless network, make sure the Wi-Fi dongle is properly installed in USB 2.0 embedded port. For more information, refer to page 26.*

BASIC OPERATIONS



Note: In **Other Options** list, you can configure additional wireless network settings, such as connecting via WPS, adding a new network, and configuring portable hotspot settings.

- Tap **Ethernet** to configure LAN settings and view the current connection status. Enter proxy settings and IP settings (DHCP or static). Tap **Reset** to reset all network settings to their defaults.

IMPORTANT! To connect to a wired network, make sure the IFP is connected to LAN. For more information, refer to page 26.



BASIC OPERATIONS

Configuring Device Settings

In **Advanced Settings** menu, tap  to open the **Device** menu, then complete the following steps:



BASIC OPERATIONS

- Tap **Device ID** to assign a new ID to the IFP. To confirm, tap **OK**.

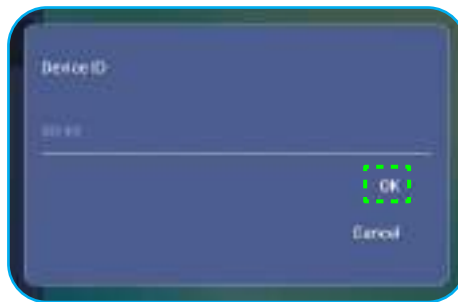

Note: Device ID is related to **Optoma ProService Device ID**.

- Tap **SAMBA Service** to enable or disable SAMBA service and configure the related parameters.

Note: When enabled, you can share folders in IFPs to other devices under the same network. To download data in IFPs to PCs, you have to establish a connection through the IP address, then you can set a password for the account for security.

- Tap **Storage** to view storage usage.



- Tap **Apps** to view apps information, clear apps data and cache, and force stop apps. Select an app in the list to view its version, clear its data (**Clear data**) and cache (**Clear cache**), and view permissions. To force stop the app, tap **Force stop**.

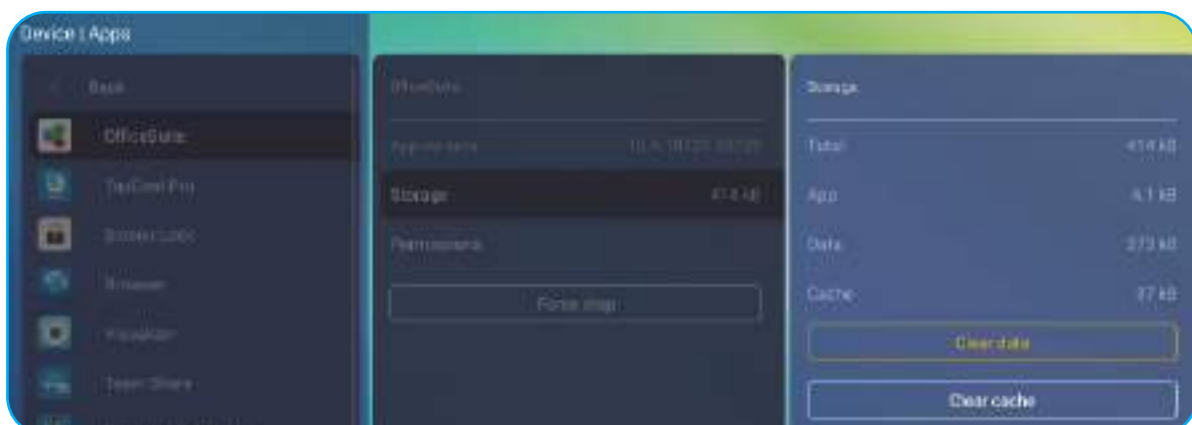

- Tap **Other Settings** to configure side toolbar, floating annotation toolbar, touch sound, and email settings. Tap any of the following:
 - ◀▶ on **Side Tool Bar Settings** item to select one of the available locations where the side toolbar is visible: All channel, only Android, or Disable
 - **Floating Point** to enable or disable floating annotation toolbar. For more information, refer to page 60.
 - **Touch Sound** to enable or disable audio feedback when you tap items on the screen.
 - **Email** to configure email settings.

BASIC OPERATIONS

Configuring Security Settings

In the **Advanced Settings** menu, tap  to open the **Security** menu, then complete the following steps:



- Tap **Password** to set screen lock password or USB/Wi-Fi access password. To set passwords, do any of the following:
 - Tap **Screen Lock Password Settings** and enter a new password twice at the prompt. To confirm, tap **OK**.
- Note:** To remove the screen lock password, tap **Clear Screen Lock Password** (visible only after password is set).

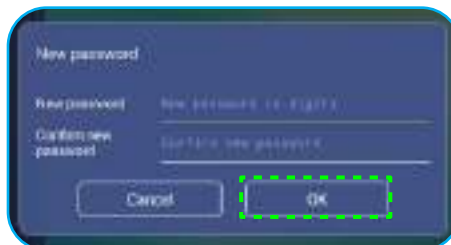

- To enable or disable USB/Wi-Fi drive and set USB/Wi-Fi access password, do the following:
 - a) Press **Source + 5 + 9 + 8 + 0** buttons on the remote control and then enter the **DEBUG MENU** access password at the **Input Password** prompt. When done, tap **OK**.

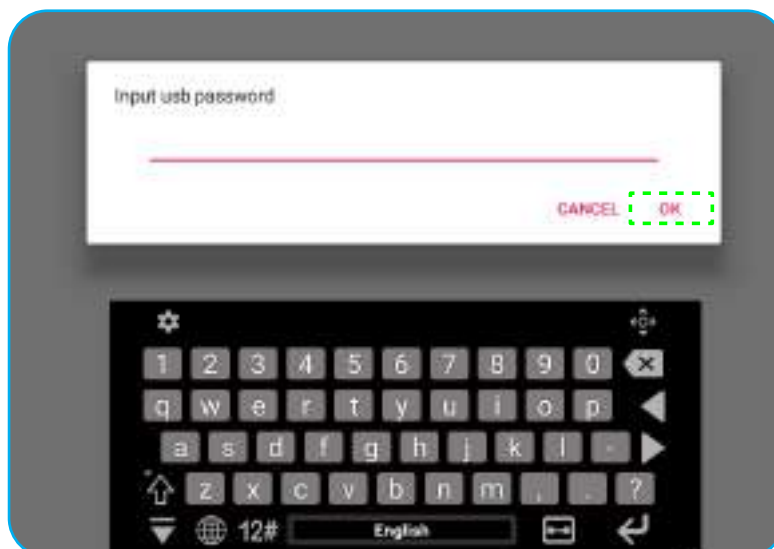

BASIC OPERATIONS

After entering the correct password, the **DEBUG MENU** opens.

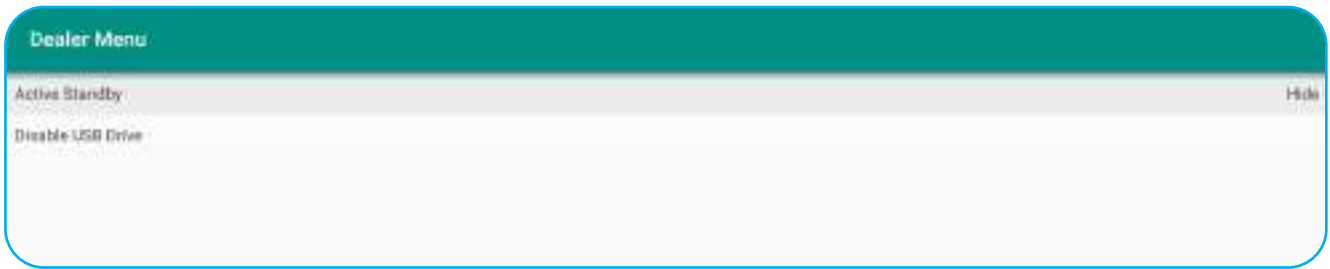

b) Tap >>> next to **Disable USB/WIFI Drive** to enable or disable the respective feature. To enable, select **ON** at the prompt or to disable, select **OFF**.

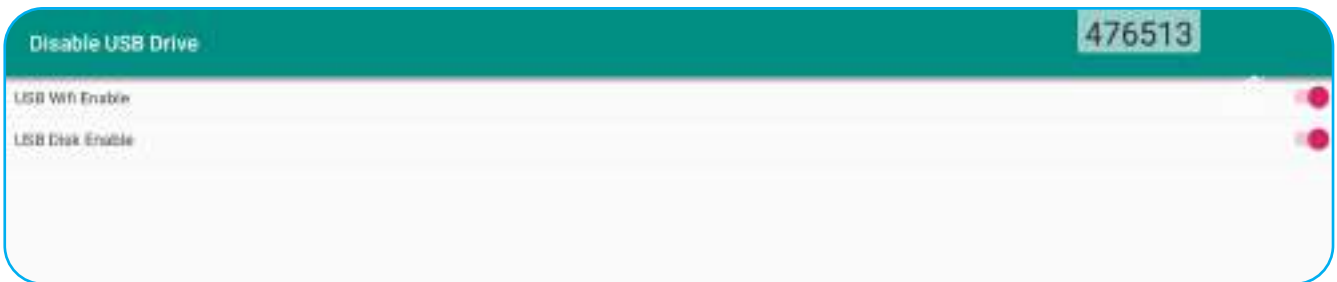

If you selected **ON**, the **Advanced Settings > Security > Password** menu opens automatically with **USB/Wi-Fi Access Password** option visible.

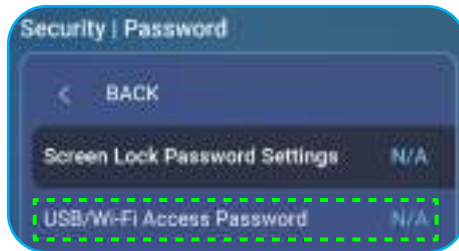

c) Tap **USB/Wi-Fi Access Password** and enter a new password twice at the prompt. To confirm, tap **OK**.

Note: To remove the access password, tap **Clear USB/Wi-Fi Access Password** (visible only after password is set).

- Tap **Unknown Sources** to enable or disable installing third party applications.

BASIC OPERATIONS

Configuring System Settings

In the **Advanced Settings** menu, tap  to open the **System** menu, then complete the following steps:



- Tap **Date and Time** to configure date and time related settings. Tap any of the following:

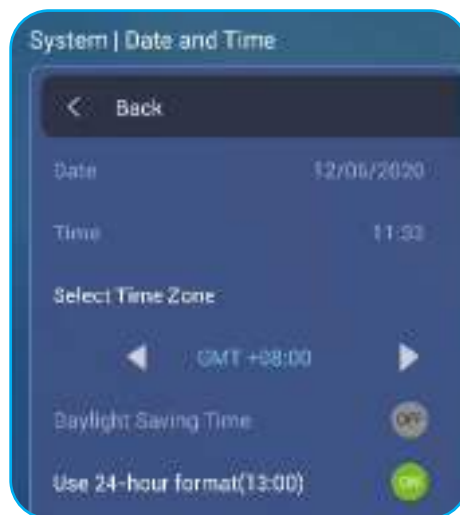

- **Select Time Zone** to select time zone in your area.
- **Daylight Saving Time** to enable or disable daylight saving time (if applicable).
- **Use 24-hour format(13:00)** to enable or disable displaying time in 24-hour format.
- Tap **Language** to select one of the available language options: English, French, Spanish, Traditional Chinese, Simplified Chinese, Portuguese, German, Dutch, Polish, Russian, Czech, Danish, Swedish, Italian, Turkish, Arabic, and Romanian.

BASIC OPERATIONS

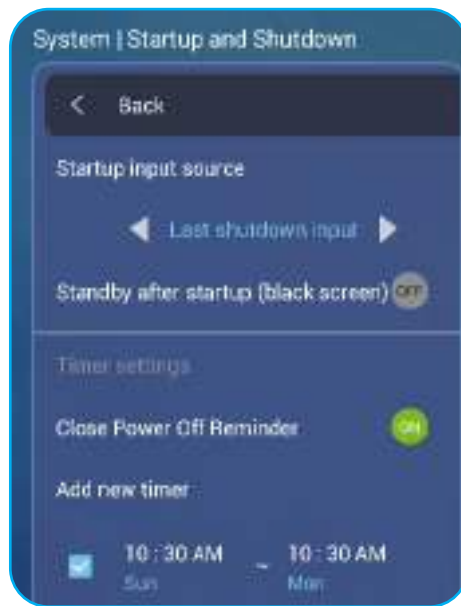

- Tap **Keyboard** to view and manage keyboards.
- Tap **Startup and Shutdown** to configure settings related to starting and shutting down the IFP. Tap any of the following:
 - ◀▶ on **Startup input source** item to select one of the available startup input options: Last shutdown input, Android, OPS, HDMI1, HDMI2, HDMI Front, Displayport, or VGA, DP.
 - **Standby after startup (black screen)** to enable or disable standby after startup.
 - **Timer settings > Close Power Off Reminder** to enable or disable closing power off reminder when the IFP is scheduled to shut down.
 - **Timer settings > Add new timer** to set a startup and power off timer. To set up a schedule, do the following:
 - a) To enable startup timer and/or shutdown timer, check the checkbox next to **Startup timer** and **Shutdown timer** checkboxes.
 - b) Set time and select day(s) when you want to startup or shut down the IFP.
 - c) Tap **Done** to save the schedule.

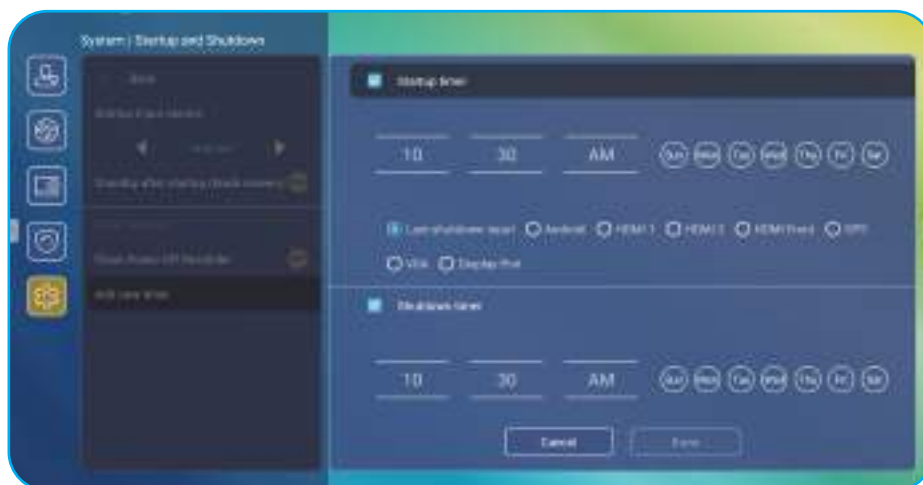

BASIC OPERATIONS

d) Check the checkbox next to the new schedule in **Advanced Settings > System > Startup and Shutdown** menu to activate the schedule.



- Tap **Power** to configure power settings. Tap any of the following:
 - **Signal Power On** to enable or disable starting up the IFP when an input signal is detected.
 - **Direct Power On** to enable or disable starting up the IFP from the power source.

Note: Direct power on feature aids installations that rely on power-on timers.
 - ◀▶ on **Auto Power Off (min.)** item to select one of the available time intervals in minutes to automatically power off the IFP when there is no input source found: Off (function is disabled), 5, 10, 15, 20, 25, 30, 35, 40, 45, 50, 55, or 60.
 - **Wake on LAN** to enable or disable remotely starting up the IFP over LAN.

Note: Wake on LAN can't work and will be gray out when Power Mode (Standby) is set to **Active**.
- Tap **HDMI CEC** to enable or disable any of the available options: Display on then player on, Display off then player off, Player on then display on, or Player off then display off.
- Tap ◀▶ on **Power Mode (Standby)** item to select one of the available options: Eco or Active. By default, **Active** item is not visible. To enable **Active** option, do the following:
 - a) Press **Input + 5 + 9 + 8 + 0** buttons on the remote control. The **DEBUG MENU** opens.
 - b) Tap **HIDE** next to **Active Standby**. Select **SHOW** at the prompt.

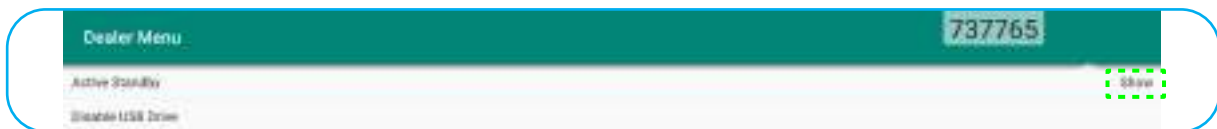

c) Tap **Exit** to exit the **DEBUG MENU**.

Active option is visible in **Advanced Settings > System > Power Mode (Standby)** menu.

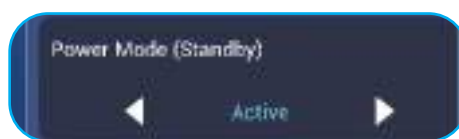

Note: **Optoma ProService** and LAN control remote power on functions will only work when Power Mode (Standby) is set to **Active**.

Note: Active Standby mode consumes higher power since system only turns off backlight and mainboard is still working to listen for power on command from LAN and **Optoma ProService**. If you don't have remote power on requirement, we suggest using **Eco**. Standby mode to save more power.

Note: It is also highly recommended that you switch back to **Eco**. Standby mode and turn off the IFP for a period of time. It will help IFP system to release memory and CPU loading.

- Tap **Update** to configure upgrading options. Tap any of the following:

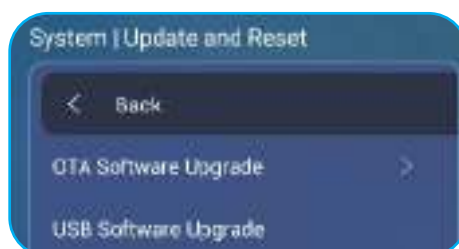

BASIC OPERATIONS

- **OTA (Over-The-Air) Software Upgrade** to enable or disable upgrading software over Internet. Tap **Auto** to enable the system to check for firmware upgrades automatically every time the IFP is powered on and connected to the Internet. If the **Auto** option is disabled, the system will not check for firmware upgrades automatically. To check for updates manually, tap **Update**.

Note: *Upgrading software over Internet requires a network connection.*

- **USB Software Upgrade** to upgrade software from a USB flash disk.

Note: *To proceed with upgrading software, save the upgrade file to the USB flash disk first, then connect the disk to an available USB port on the IFP. Open **Advanced Settings > System > Update > USB Software Upgrade** and tap **Start** at the prompt.*

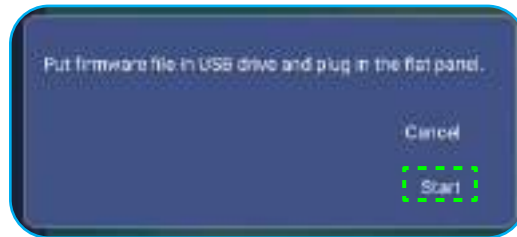

Note: *If you upgrade IFP's firmware from a USB storage, uncompress the upgrade file first and then copy the uncompressed file to the USB root directory. Make sure the USB flash disk is formatted as FAT32.*

IMPORTANT! *During the update process, either OTA or from a USB storage, DO NOT power off the IFP and DO NOT remove the USB dongle from the IFP. Doing so will damage the system.*









BASIC OPERATIONS

Side Toolbar

Tap  or  to open the side toolbar. You can drag the panel to change its position on the screen.





Side toolbar

- To hide the toolbar, tap .
- To return to the previous screen, tap .
- To return to Home screen, tap .
- To view recent tasks, tap . For more information, refer to “Viewing Recent Tasks” on page 52.
- To open **Setup** menu, tap .
- To open **Team Share** app, tap . For more information, refer to “Team Share App” on page 53.
- To open annotation app, tap .
- To freeze the current screen, tap .
- To open screen recording feature, tap . For more information, refer to “Screen Recorder” on page 60.

BASIC OPERATIONS

Viewing Recent Tasks

Tap  >  to view all of your recently used apps.

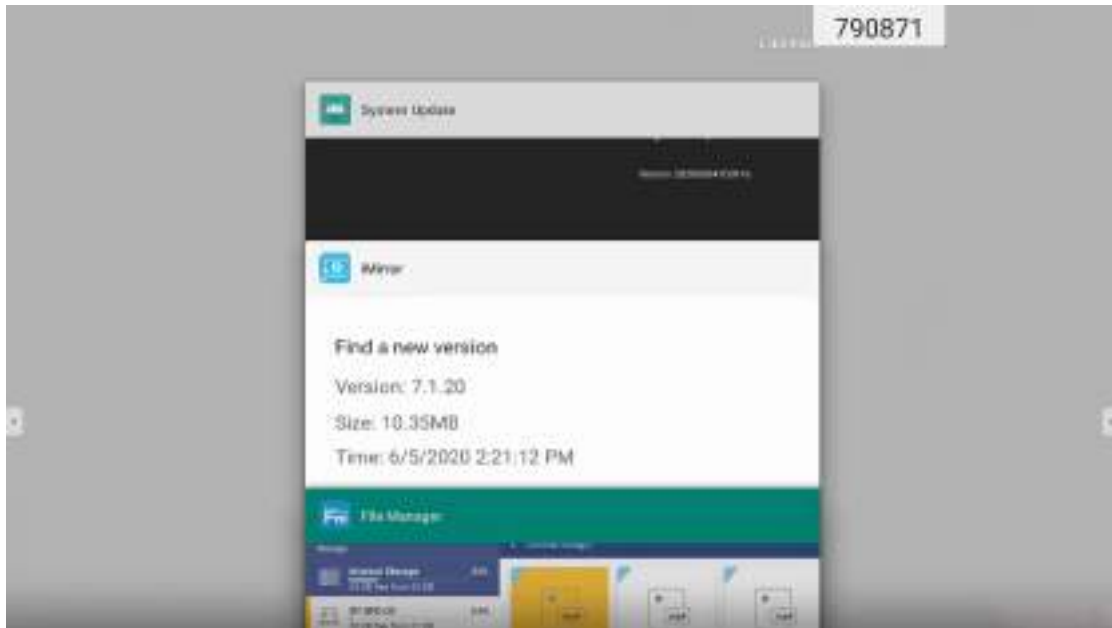

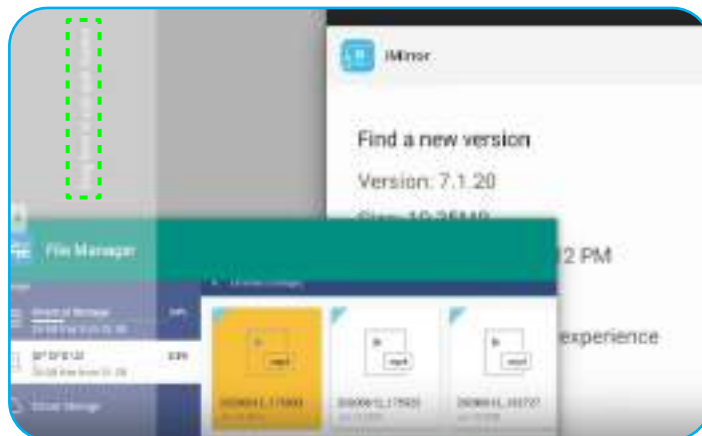

- Tap on the app you want to launch.
- To remove the app from the list, swipe it left or right.
- To clear the list, swipe the list downwards first (if necessary), then tap **CLEAR ALL**.
- To use split screen, tap and hold on the desired app for a few seconds, then drag the app window to the left or to the right of **Drag here to use split screen** column.



Note: You can also view recently used apps in floating annotation toolbar. Refer to “Floating Annotation Toolbar” on page 60.

BASIC OPERATIONS



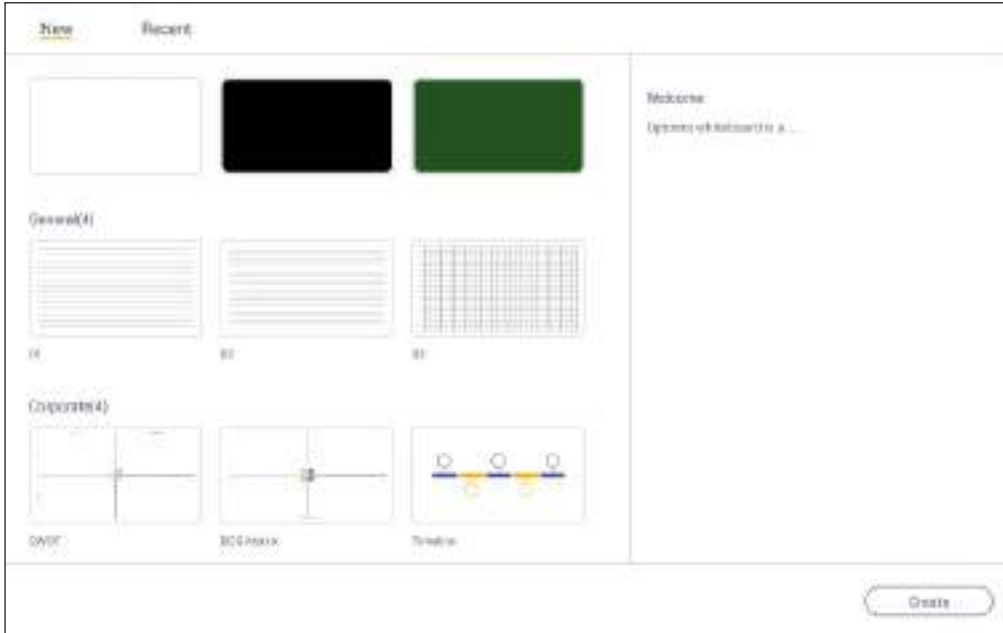

Team Share App

Tap  >  to open **Team Share** app. You can write, scribble, or draw on the virtual whiteboard.











To start using the app, do the following:





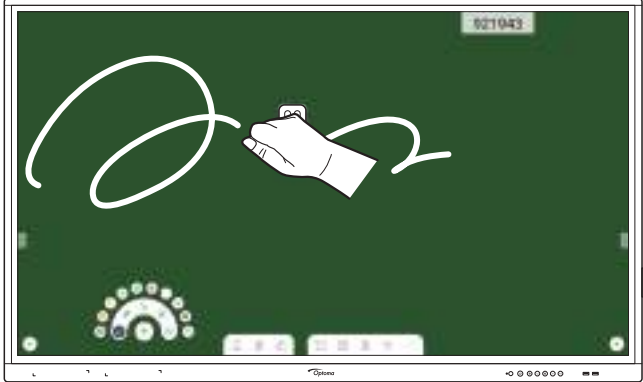





1. In **New** tab, select a background or template for your content.
Note: To open a previously saved project, tap **Recent**, select your desired project, and then tap **Open**.
2. Tap **Create** and use any of the activities described in the table below:

Item	Description
	<p>Tap and drag the board or long-tap on the screen to move the board to your preferred location on the screen.</p> 
	<p>Close the board. The board is minimized to a single icon. Tap the icon to reopen the board. For example, :</p>









BASIC OPERATIONS

Item	Description
 Pen	<p>Write or draw a freeform line. Tap to select the desired line thickness and color.</p>  <p>IMPORTANT! Avoid damaging the virtual whiteboard. For writing and drawing, use ONLY the supplied touch pen or your fingers.</p> <p>Note:</p> <ul style="list-style-type: none"> • To change the Colour/Color palette, tap . • Touch pen is supplied with thick tip and thin tip. The app can detect automatically which tip (/ ) you are using and displays the options based on the tip thickness. • If you are using your fingers to write or draw on the virtual whiteboard then it is considered as using a “thick tip pen”.
 Eraser	<p>Erase areas of your written texts or drawings. Select the eraser size and drag your fingers over the area you want to remove.</p>  <p>Note: You can also use the palm of your hand to erase the item on the whiteboard.</p> 
 Erase All	<p>Erase all written texts and drawings on the virtual whiteboard.</p>





BASIC OPERATIONS

Item		Description
	Select	<p>Select an object on the whiteboard. Tap any of the following to alter the selected area:</p>  <ul style="list-style-type: none"> •  (boundary point) to enlarge or diminish. •  to rotate. •  to duplicate. •  to delete.
	Geometric shape	<p>Draw a geometric shape. Tap to select the desired 2D or 3D shape with several color options.</p> 
	Import file	<p>Import images from different storage devices, including internal storage, USB storage, or cloud drive.</p>
	Menu	<p>Tap any of the following options:</p> <ul style="list-style-type: none"> • New to create a new file. • Open to open an *.iwb format file. • Save to save the current content as an IWB file. •  to open Settings menu. Then enable or disable auto saving and eye protection writing mode, check for software updates, and manage cloud storage accounts. • ? to open Team Share app tutorial.

BASIC OPERATIONS

Item	Description
 Export file	<p>Select one of the available options to export a file. Tap any of the following:</p> <ul style="list-style-type: none">  to export the file to an internal/external storage or cloud storage. Note: For more information on cloud storage account management, refer to “Cloud Storage” on page 70.  to share the file with QR code. <div data-bbox="743 521 1145 947" style="border: 1px solid #00aaff; border-radius: 15px; padding: 10px; margin: 10px 0;"> <p style="text-align: center; font-size: small;">Share with QR code</p> <p style="text-align: center; font-size: x-small;">Ensure your device is connected to the same Wi-Fi. Then scan the QR code.</p> <div style="text-align: center;">  </div> <p style="text-align: center; font-size: x-small; margin-top: 10px;">Close</p> </div> <p>Note: Before scanning the QR code to view the file, make sure the IFP and your mobile device are connected to the same Wi-Fi network.</p> <ul style="list-style-type: none">  to send the file by email. Note: If you want to send the file by email for the first time, you are prompted to configure email settings first.
 Page manager	<p>View and manage all pages that are involved in the current project. Tap any of the following:</p> <ul style="list-style-type: none">  to add a page.  to remove a page. <div data-bbox="427 1312 1461 1666" style="border: 1px solid #00aaff; border-radius: 15px; padding: 10px; margin: 10px 0;">  </div>

BASIC OPERATIONS

Item		Description
	Background options	Select a background or template for your content. 
	Undo	Undo your last action.
	Redo	Redo your last action.
	Add page	Add a new page.





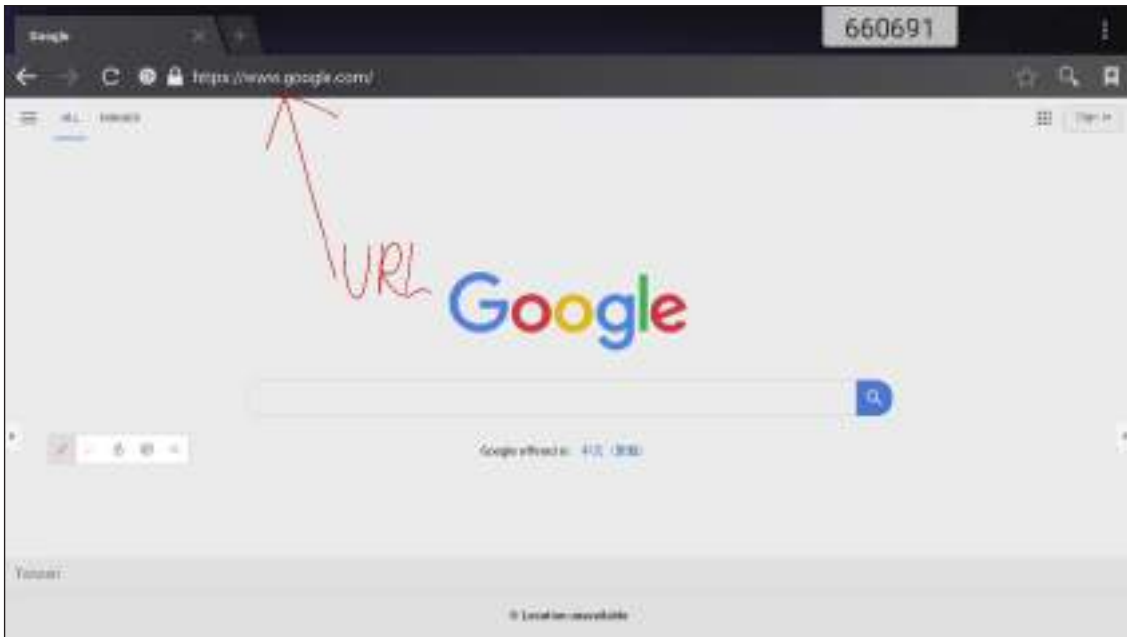

BASIC OPERATIONS

Annotation App

Tap  >  to open annotation app.





In this mode, you can do the following:

- Tap  to write and draw on the screen.
Note: You can change the pen color by tapping  repeatedly.
- Tap  to highlight the item on the screen.
Note: You can change the highlighter color by tapping  repeatedly.
- To erase all annotations on the screen, tap .
Note: You can also use the palm of your hand to erase the areas of your written texts or drawings.
- To capture a screenshot of the entire screen, tap .
- To exit the current mode, tap .





BASIC OPERATIONS

Screen Freezing

Tap  >  to freeze the current screen.



In this mode, you can do the following:





- To zoom in, tap . Then you can pan and move around the image.
Note: *Each tap increases the magnification.*
- To zoom out, tap .
Note: *You can also pinch with two fingers on the screen to zoom in or out.*
- To restore the image to its original size, tap .
- To exit the current mode, tap .

BASIC OPERATIONS

Screen Recorder

Tap  >  to open screen recording utility. This utility helps you to record video from the IFP's screen.









- Tap  to start recording the screen. While recording, tap  to pause recording or  to stop recording, then select a location where to save the recording and tap **OK**.
- Tap  to configure recording settings: video resolution, and default path where recordings are saved.
Note: *By default, all recordings are saved to the Record folder.*
- Tap  to close the recording tool.

Floating Annotation Toolbar

Touch the screen with your two fingers, a centimeter apart from each other. The floating annotation toolbar opens.



- Tap  to return to the previous screen.
- Tap  to return to Home screen.
- Tap  to open annotation app.
- Tap  to open **Team Share**.
- Tap  to view recent tasks. Tap the task you want to switch to or tap  to close the annotation toolbar.
- Tap  and drag the annotation toolbar to your preferred location on the screen.

USING THE APPS

From the Home screen, tap **⋮** to view the Apps list.

IMPORTANT! *The embedded Android 8.0 operation system is not standard Android. As such, Google Play is not available in the Apps list. The installed third party application might not work properly if it is not designed for IFP. Optoma will not guarantee that these self-installed Apps work. Optoma interactive flat panel displays run a customized Android operating system and do not support Google Play Services. The operating system may not be compatible with all third-party Android apps. Third-party Android apps can vary in quality and some even contain malicious codes, which could compromise system security and may invalidate product warranty. Optoma makes no representations regarding the quality, security or suitability of any third-party apps and their compatibility with the Optoma interactive flat panel. Optoma shall have no responsibility or liability with respect to any damage, faults, loss in functionality or security issues arising as a direct or indirect result of the installation of third-party apps on the interactive flat panel. Optoma support in rectifying any issue which may result from the installation of third-party apps will be chargeable and may be limited. Information is correct at the time of writing and is subject to change.*



Note: To install a third party application, you have to enable the **Unknown sources** setting first in the **Advanced Settings > Security** menu. Refer to “Configuring Security Settings” on page 45.

USING THE APPS





TapCast Pro

Tap  **TapCast Pro** to project your mobile device or your computer display to the IFP through Wi-Fi or LAN connection.

IMPORTANT!

- *The IFP and your mobile device/computer must be connected to the same Wi-Fi or LAN network.*
- *During the operation, make sure that you have access to the Internet.*

TapCast Pro App Compatibility Table

Operating System	Available Version
 Windows	Windows 7/8/10
 Mac	OSX 10.8 or later
 iPhone	iOS 9.0 or later
 Android	Android 5.0 or later
 Chrome	Chrome OS 65 or later

Mobile Device

When the setup guideline screen appears, scan the QR code to download and install the **TapCast Pro** app onto your mobile device.



USING THE APPS

To share the screen, complete the following steps:

1. Launch the **TapCast Pro** app. Enter the TapCast password and tap **OK** to establish the connection.

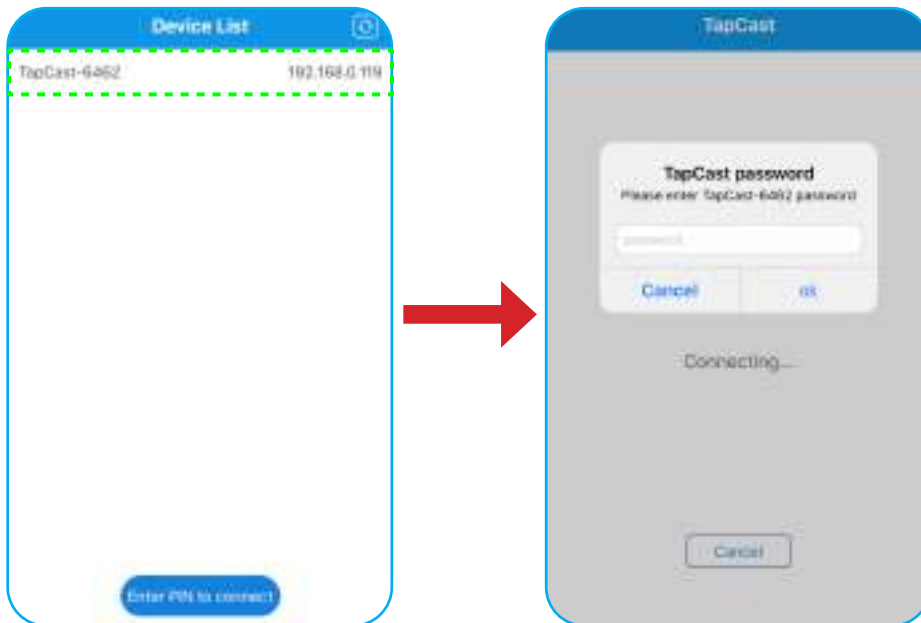

Note: You can obtain the password for the wireless connection setup on the setup guideline screen.

2. Tap any of the following:

- **Storage** to listen to music stored in your mobile device.
- **Photo** to view photos stored in your mobile device.
- **Document** to view files stored in your mobile device.
- **Upload APK** to upload apps from you mobile device to the IFP.
- **Camera** to turn on the camera of your mobile device and transfer the image captured by the camera to the IFP.
- **Remote** to use your mobile device as a remote control to control the IFP.
- **Applications** to allow your mobile device to remotely launch the apps installed on the IFP.
- **Desktop** to mirror the IFP screen to your mobile device. You can use your mobile device to operate the IFP. To end the remote session, tap
- **Desktop with annotation** to mirror the IFP screen to your mobile device with annotation feature enabled. You can use your mobile device to operate the IFP. To end the remote session, tap



USING THE APPS

Mobile Device Screen-Casting

To mirror your iOS mobile device screen to the IFP, drag the bottom of the screen upwards to open **Control Center** > **Screen Mirroring**, then tap on the device. To end the remote session, tap **Stop Mirroring**.

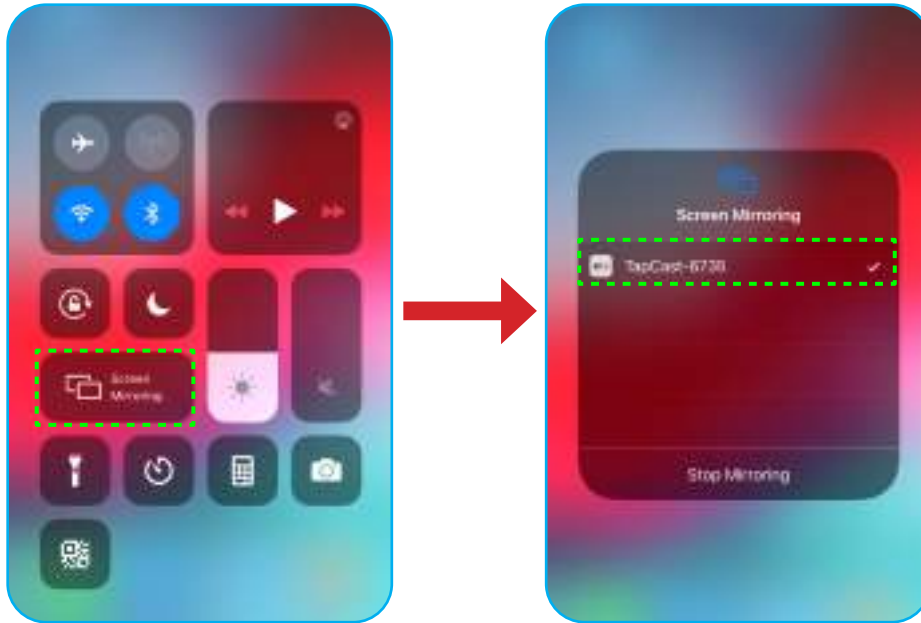

Computer

Go to <https://www.optoma.com/ifp/> to download the **Share Sender** app. Then install the app onto your computer.

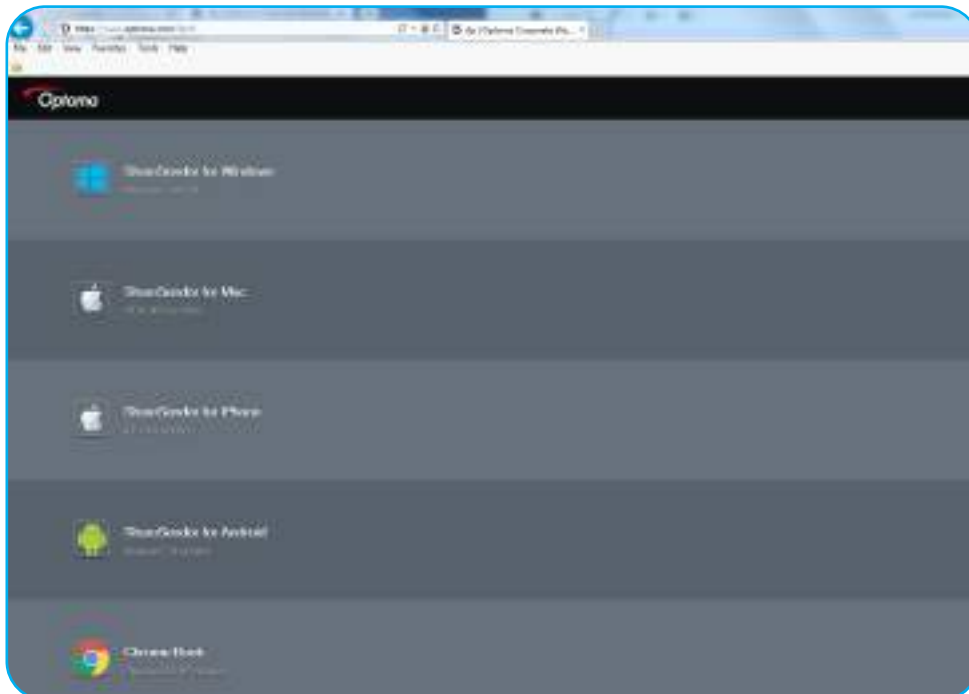

USING THE APPS

To share the screen:

1. Launch the **TapCast Pro** app. Then enter the TapCast password to establish the connection.



Note: You can obtain the password on the IFP's screen.

2. Once connected, tap any of the following:
 - **Start** to mirror the screen of your computer to the IFP.
 - **Screen Mirror** to mirror the screen of the IFP to your computer with control feature enabled.
 - **Annotate** to mirror the screen of the IFP to your computer with annotation feature enabled.



3. To stop sharing the screen, tap **Disconnect**.

USING THE APPS





TapCast Pro Advanced Settings

Tap any of the following icons to configure **TapCast Pro** advanced settings:



- **Settings**  to rename the device, run the **TapCast Pro** app by default after starting the IFP, show or hide the PIN code, and enable or disable split screen (4 screens) feature. Tap **Finish** to save settings and exit the **Settings** menu.



- **Permission**  to manage access control permissions. Follow the steps below:
 - a) Slide the **Permission** switch to ON.
 - b) Tap  next to the device you want to edit permissions.
 - c) Tap any of the following icons to:
 -  grant screen sharing access.
 -  grant full screen access.
 -  revoke access.

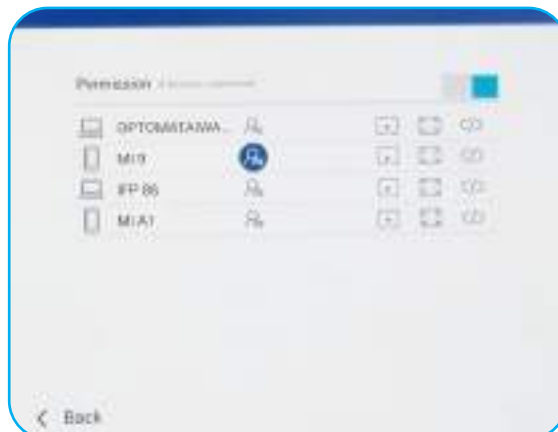

USING THE APPS

- **Grouping Display**  to enable or disable the function. If enabled, select devices where you want to share casting screen. Tap **Refresh** to refresh the device list, **OK** to save settings and exit the **Grouping display...** menu, or **Back** to exit without saving.

Note: You can also display only these devices that support screen sharing by enabling **Only Valid for Screen Sharing**.



USING THE APPS







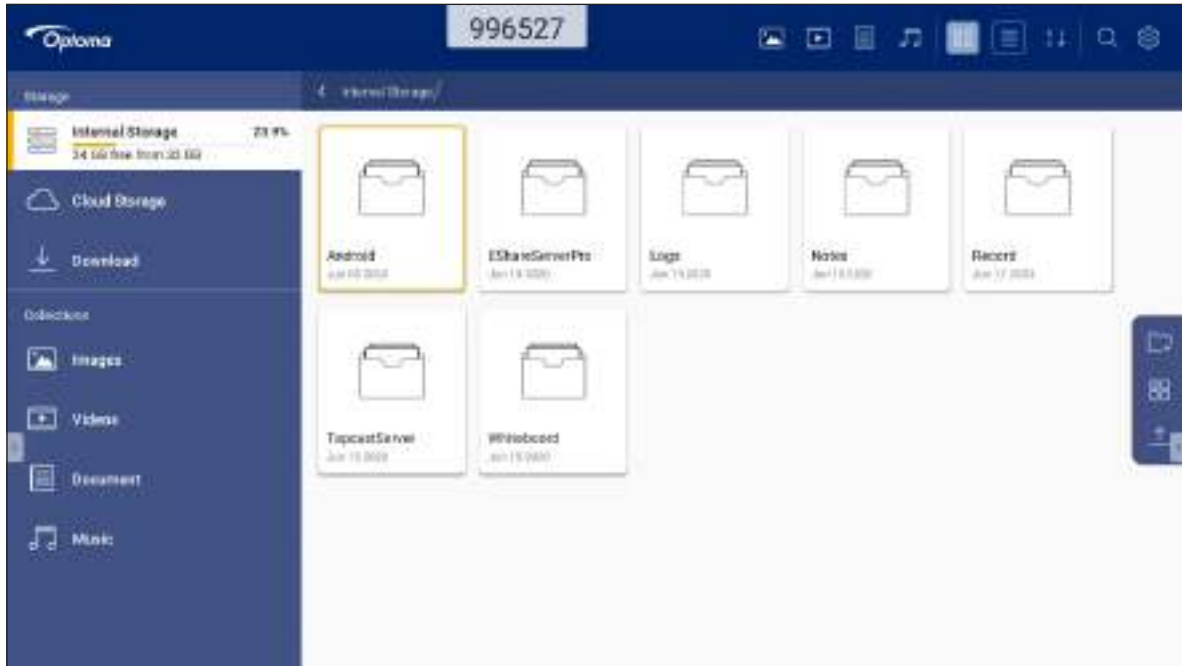



File Manager

Tap **File Manager** to manage files and folders.















Managing Files



Select a storage and browse for a file or folder you want to view, then do any of the following:

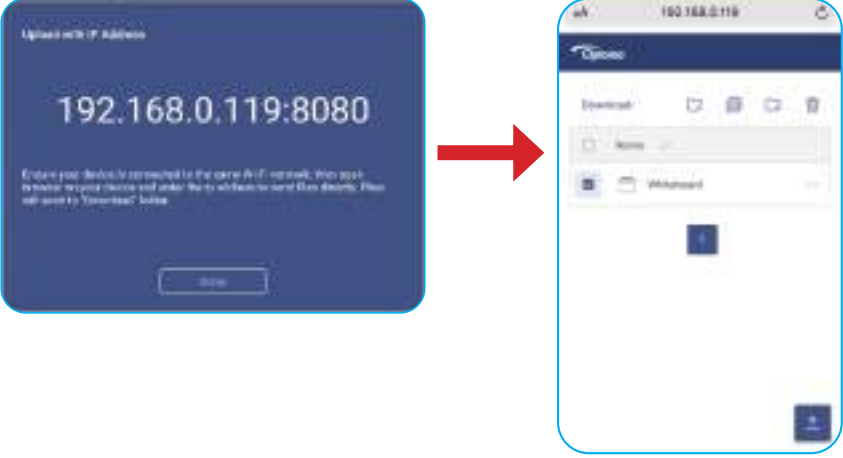

Item	Description
 Images	Display image files.
 Videos	Display video files.
 Document	Display documents.
 Music	Display audio files.
 Thumbnail view	View content as thumbnails.
 List view	View content as a list.
 Sort	Sort content by name or by date in ascending or descending order.
 Search	Search files and folders.
 Software version	View software version and update app (if necessary).
 New Folder	Create a new folder.

USING THE APPS

Item	Description
	<p>Select files and folders. When selected, tap any of the following:</p> <ul style="list-style-type: none">  undo your last action.  check/uncheck all items.  cut and paste item(s).  copy and paste item(s).  delete item(s).  rename an item.  share an item with QR code. <p>Note: For file sharing with QR code, make sure your mobile device is connected to the same Wi-Fi as the IFP.</p> <div style="text-align: center;">  </div> <ul style="list-style-type: none">  compress item(s).  move/copy item(s) to another location or view item details.
	<p>Share item(s) between the IFP and your mobile device over web browser.</p> <div style="text-align: center;">  </div> <p>Note:</p> <ul style="list-style-type: none"> By default, all items that you upload to the IFP are saved to Download  folder. For item(s) upload, make sure your mobile device is connected to the same Wi-Fi as the IFP.

USING THE APPS

Cloud Storage

Tap **File Manager**  > **Cloud Storage**  to create an account or use an existing account to access your cloud storage.

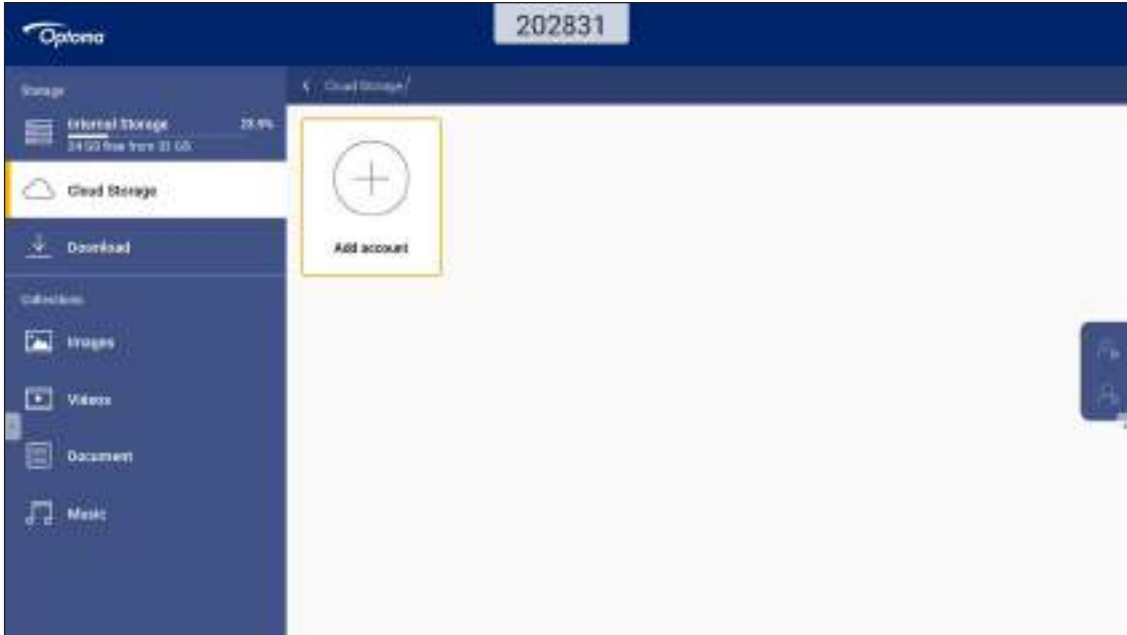

To create an account:

1. Tap **Add account**.
2. Select the drive type.



3. Follow on-screen instructions to create an account or sign in to your existing account.
4. After successful login, you are prompted to set a security PIN. Tap **Setup** to set the PIN or **Skip** to skip this step.



Note: PIN code is used to protect user's cloud storage from being illegally deposited. When system status changes (for example, from standby to normal, from backlight off to on), if someone wants to access this cloud storage, he needs to key in PIN code for verification.

USING THE APPS

Your account will be listed in the **Cloud Storage** menu.



Playing Multimedia Files

Multimedia support format

Media Type	Supported Format
Video	<p>Video support format (codec) up to 4K resolution:</p> <ul style="list-style-type: none"> .avi (MPEG-1, MPEG-2 MP@HL, MPEG-4 SP@L0-3, ASP@L0-5, H.264, MP, HP@Level 4.1, H263, VP6, MJPEG) .ts (MPEG-2 MP@HL, MPEG-4 SP@L0-3, ASP@L0-5, H.264 MP, HP@Level 4.1, VC1 AP, H265) .mpg, .mpeg (MPEG-1, MPEG-2 MP@HL, H.264 MP, HP@Level 4.1) .mp4 (MPEG-4 SP@L0-3, ASP@L0-5, H.264 MP, HP@Level 4.1, H265) .mov (MPEG-4 SP@L0-3, ASP@L0-5, MJPEG, H.264 MP, HP@Level 4.1, H265) .mkv (VP9, H.265) 3gp (H.264 MP, HP@Level 4.1, H263, MPEG-4 SP@L0-3, ASP@L0-5)
Audio	<p>Audio support format (codec):</p> <ul style="list-style-type: none"> .wma (WMA/WMAPro: 128Kbps~320Kbps, 8KHz~48KHz sampling rate) .mp3 (MPEG Layer 3: 32Kbps~320Kbps, 32KHz~48KHz sampling rate) .wav (PCM: Max 320Kbps, Max 48kHz sampling rate / ADPCM: 384Kbps, 8KHz ~ 48KHz sampling rate) .m4a (ACC: 24kbps ~ 384kbps, 16KHz~48KHz sampling rate) .ogg (Vorbis: Max 320Kbps, 8KHz~48KHz sampling rate)
Image	<p>Supported image format (with the maximum resolution):</p> <ul style="list-style-type: none"> *.png (8k*8k) *.jpeg (baseline 8k*8k; progressive 4k*4k) *.bmp (8k*8k) *.gif (4k*4k)













USING THE APPS

Playing videos

Select the video you want play and tap ▶ to start the playback.



During the playback, you can do the following:

Item	Description
 Replay	Play back the video
 Previous video	Skip to the previous video.
 Speed up	Speed up the video
 Pause	Pause the playback. To resume, tap  .
 Next video	Skip to the next video.
 Clock	Show how long the video played
 Play List	Show all play file name
 Information	Show the information of video content
 Playing Settings	Setting including of 3D, subtile , video track, Open HDR..and else
 Loop	Loop Player is an A - B repeating video
 Volume	Adjust the volume level.







USING THE APPS

Playing music

Select the song you want play and tap  to start the playback.



During the playback, you can do the following:











Item	Description
 Previous video	Skip to the previous video.
 Pause	Pause the playback. To resume, tap  .
 Next video	Skip to the next video.
 Play List	Show all play file name
 Loop	Loop Player is an A - B repeating video
 Information	Show the information of video content

USING THE APPS

Viewing photos

Tap to select a photo and view the selected photo in full screen.



Item		Description
	Zoom in	Magnify the photo.
	Zoom out	Zoom out on the magnified photo.
	Previous photo	Skip to the previous photo
	Slide show	Start the slide show. To stop, tap  .
	Next photo	Skip to the next photo.
	Rotate Left	Rotate the photo 90-degree counter-clockwise.
	Rotate Right	Rotate the photo 90-degree clockwise.
	Settings	Configure the slide show settings.
	Information	Display the photo information.
	Wall Paper	Configure the wallpaper

USING THE APPS

Screen Lock



Tap **Screen Lock** to set the 4-digit pin code. Using the pin code, you can block the IFP from unauthorized use.

To set the pin code for the first time, launch the **Screen Lock** app. Then tap **Set password**.

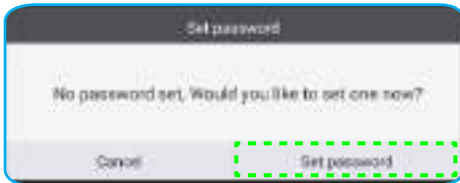

The **Advanced Settings > Security** menu opens. To set the password, refer to “Configuring Security Settings” on page 45.

Browser



Tap **Browser** to access web pages.



USING THE APPS

Performance Optimization

Select **Performance Optimization** to clean and optimize the data on the IFP.

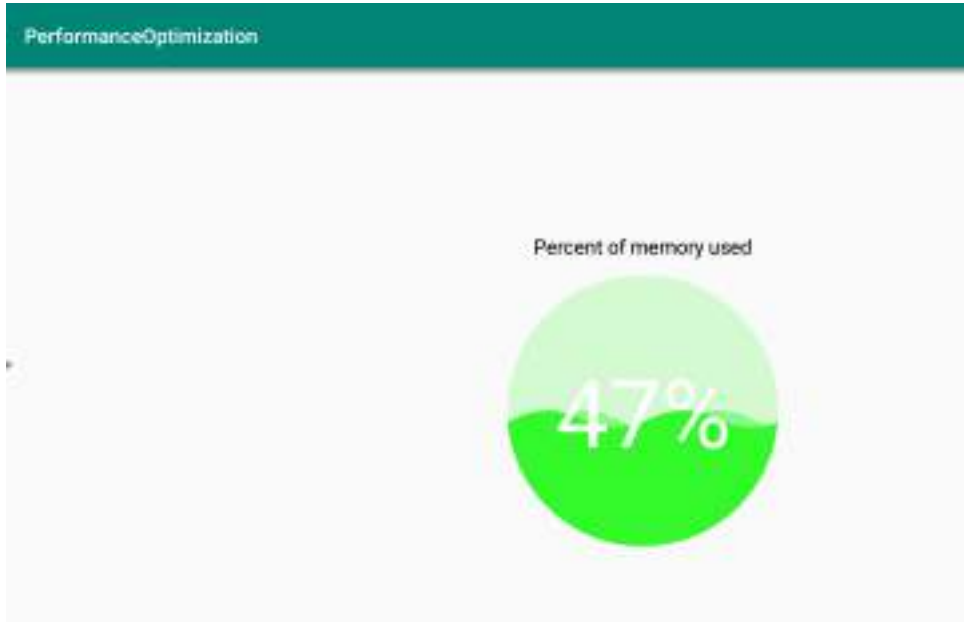

Joan on TV

Tap **Joan on TV** to get the access PIN number. Use this PIN to connect the IFP to Joan Portal.

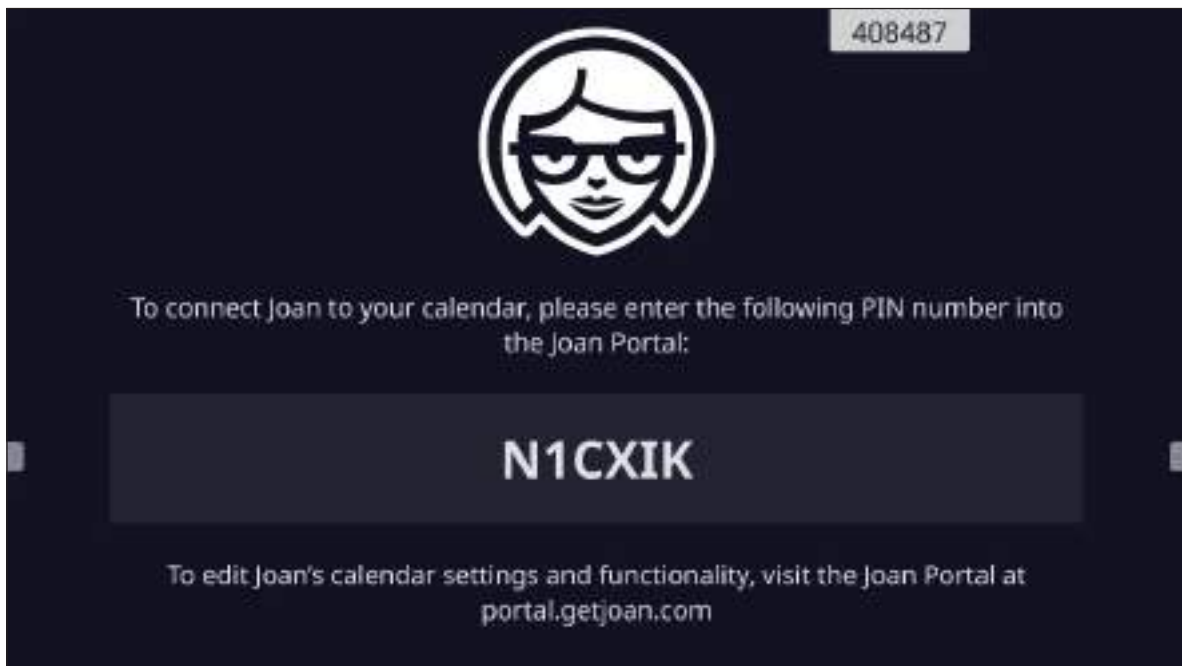

After successful connection, the IFP will display meeting room(s) schedule, meeting reminders, and meeting room reminders that are set in Joan Portal.

USING THE APPS



To connect the IFP to the Joan Portal, complete the following steps:

1. Open the web browser on your computer and enter <http://Portal.getjoan.com> into the address bar. The Joan Portal login page opens.
2. Sign in to the Joan Portal.

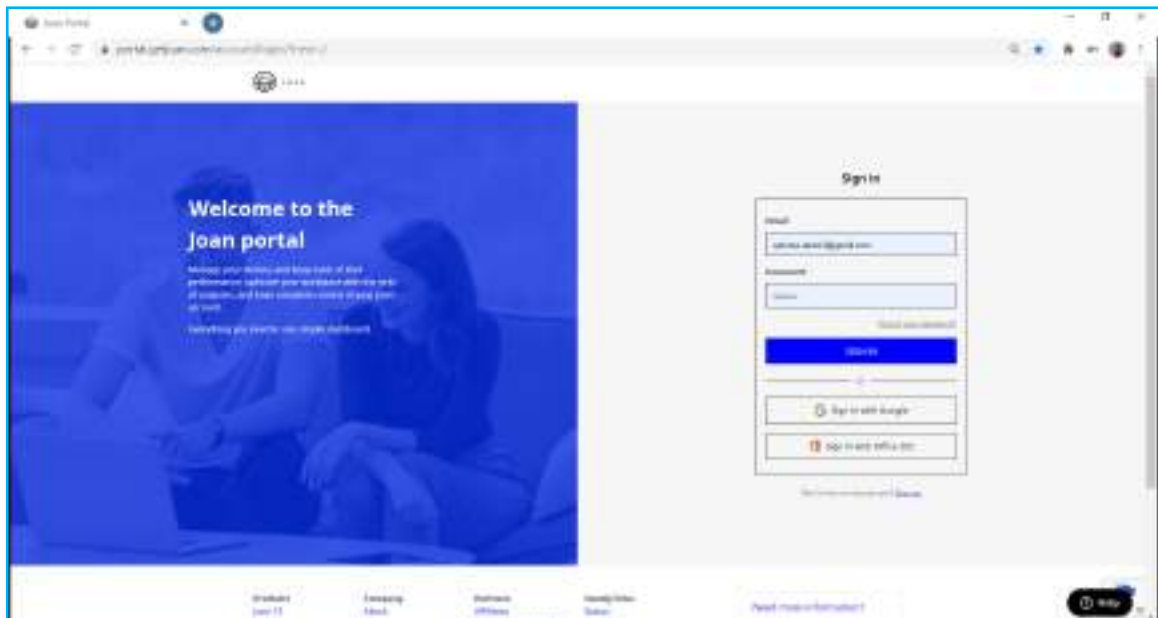

USING THE APPS

3. Create a meeting room in **Manage > Rooms > Add a room.**

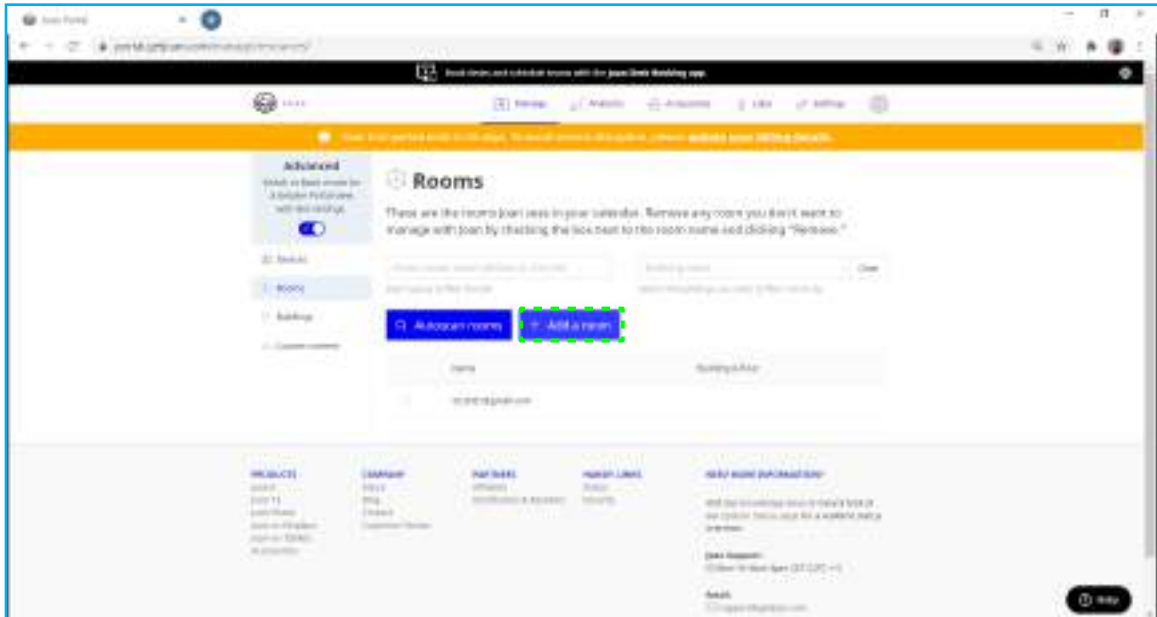

4. Connect the IFP to the Joan Portal in **Manage > Devices > Add device.**

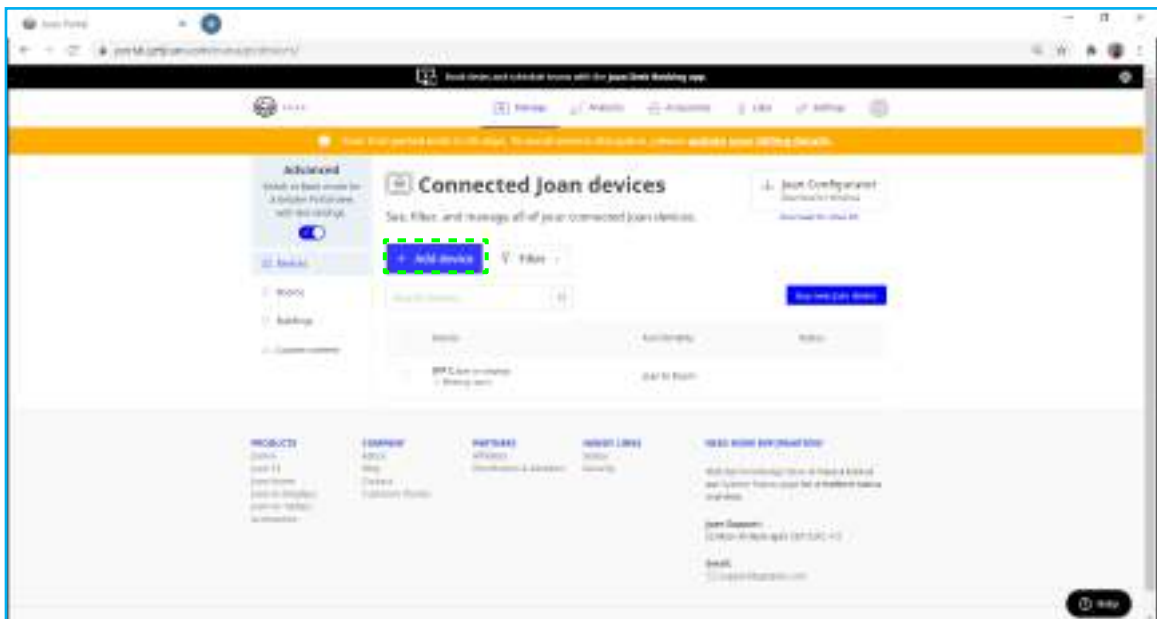

USING THE APPS

5. Enter the **Device PIN**, and then click **Pair device**.

Note: To get the PIN number, tap **Home screen** > **⋮** > **Joan on TV**.

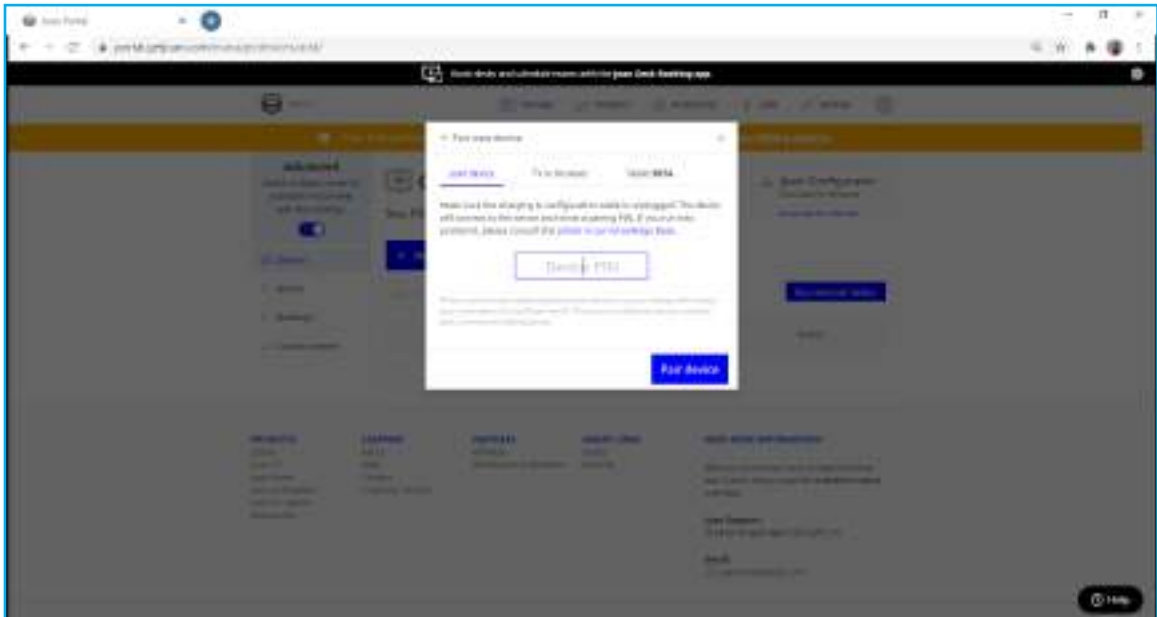

6. Connect the IFP and the meeting room in **Manage > Devices**.

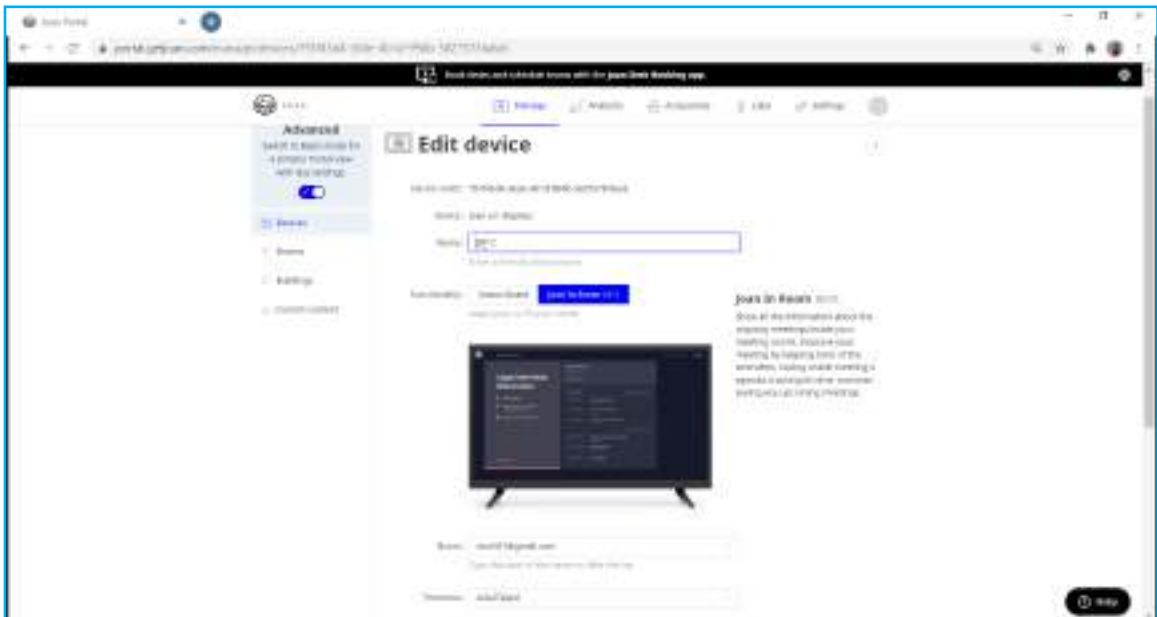

ADDITIONAL INFORMATION

Dimensions

65-inch

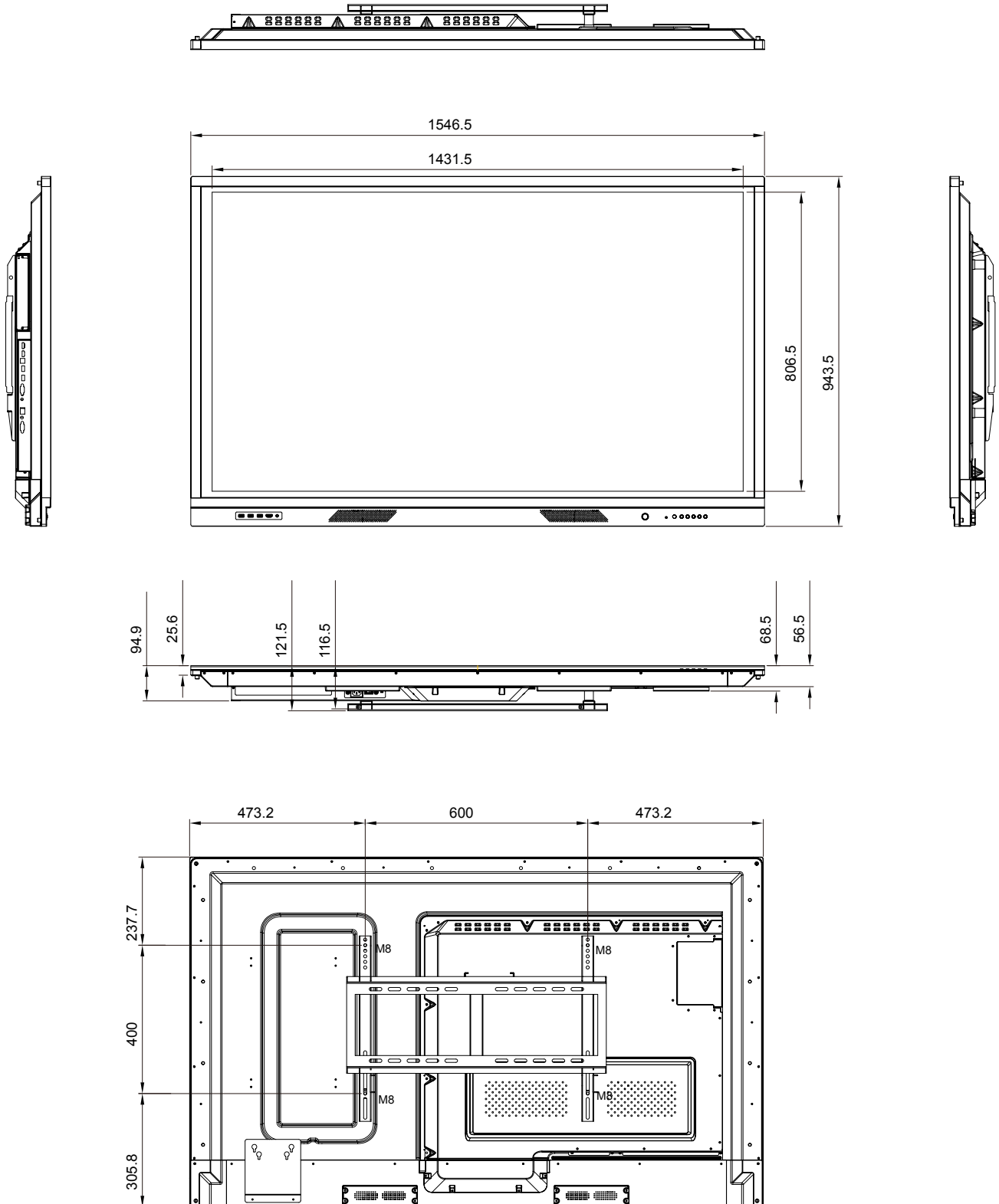

ADDITIONAL INFORMATION

75-inch

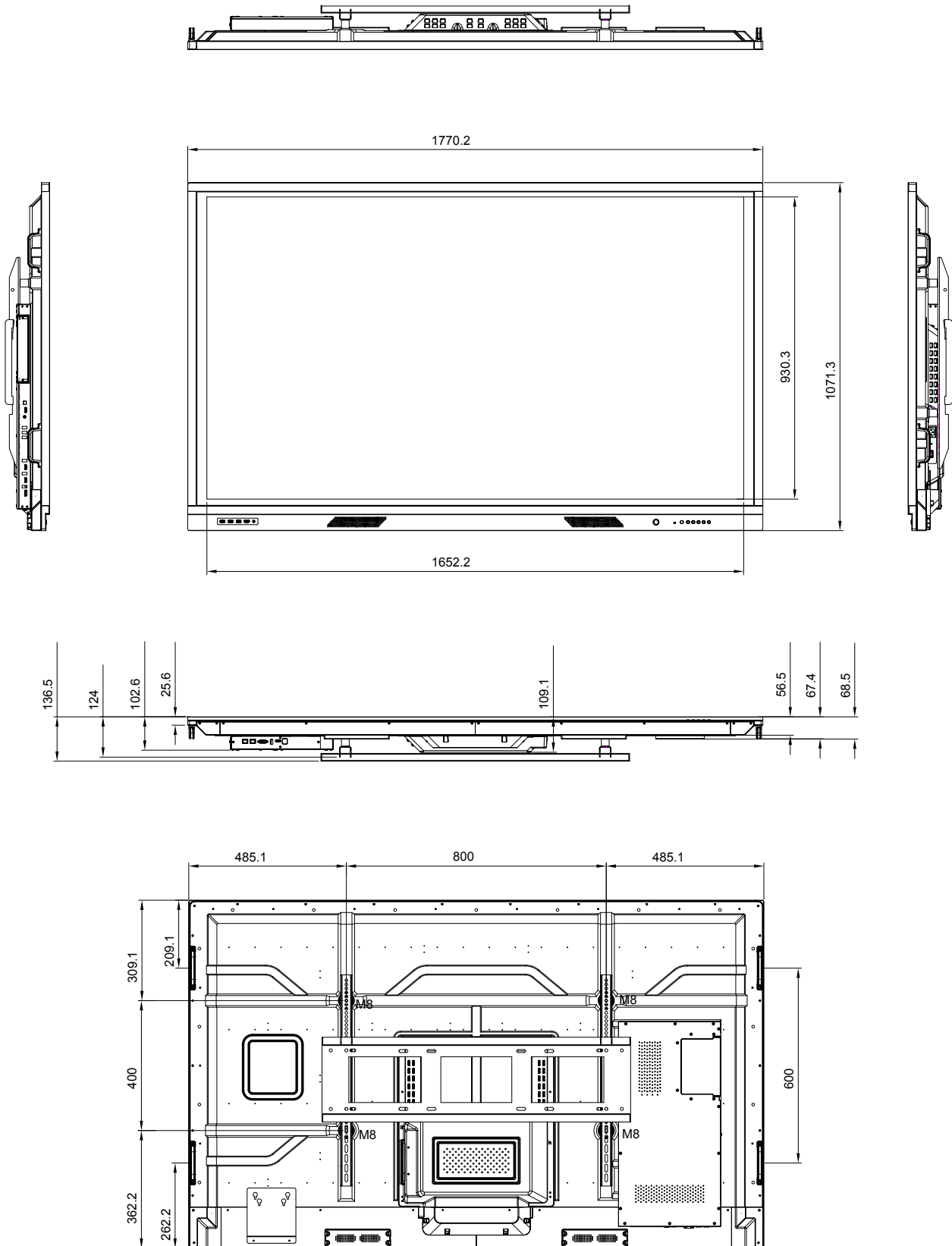

ADDITIONAL INFORMATION

86-inch

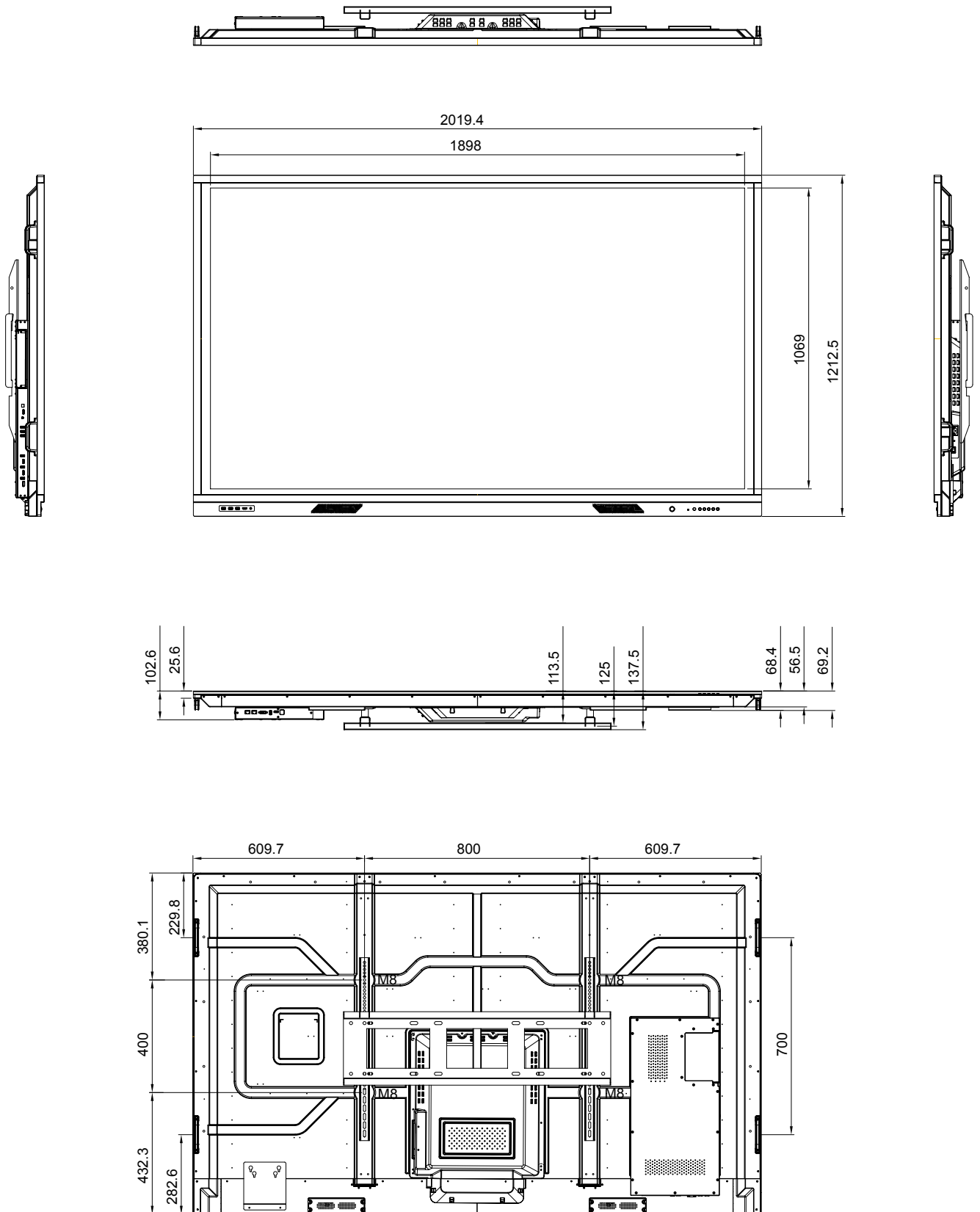

ADDITIONAL INFORMATION

Supported Timing List

Resolution	Input Source		
	HDMI (1/2/Front) 2.0	DP (1.4)	VGA
72 x 480i@60Hz	√	√	-
720 x 480p@60Hz	√	√	-
800 x 600@60Hz	√	√	-
1024 x 768@60Hz	√	√	√
1280 x 720p@50Hz	√	√	√
1280 x 720p@60Hz	√	√	-
1920 x 1080i@50Hz	√	√	-
1920 x 1080i@60Hz	√	√	√
1920 x 1080p@24Hz	√	√	-
1920 x 1080p@50Hz	√	√	-
1920 x 1080p@60Hz	√	√	√
1280 x 960@60Hz	√	√	-
1280 x 1024@60Hz	√	√	√
1366 x 768@60Hz	√	√	√
1680 x 1050@60Hz	√	√	-
1280 x 720@60Hz	√	√	-
1920 x 1080@60Hz	√	√	√
3840 x 2160p@24Hz	√	√	-
3840 x 2160p@25Hz	√	√	-
3840 x 2160p@30Hz	√	√	-
3840 x 2160p@50Hz	√	√	-
3840 x 2160p@60Hz	√	√	-
1280 x 768@60Hz	-	-	√
1600 x 1200@60Hz	-	-	√
1920 x 1200@60Hz	-	-	√

Note: “-” indicates the current input timing is not supported by the IFP.

ADDITIONAL INFORMATION

RS232 Protocol Function List

Note: IFP supports RS232 and RJ45 (port 23) control command.

RS232 Pin Assignments

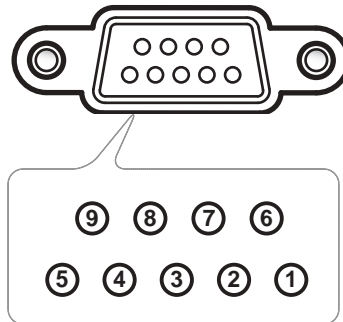

Pin No.	Spec. (from IFP side)
1	N/A
2	RXD
3	TXD
4	N/A
5	GND
6	N/A
7	N/A
8	N/A

RS232 RJ45 Control Connection

RS232 Settings	
Baud Rate	9600
Data Bits	8
Parity	None
Stop Bits	1
Flow Control	None

LAN Control Settings	
IP	Machine IP
Port	23

~	X	X	X	X	X	X	X	CR
Lead Code	Device ID (where 01 indicates Device ID = 01)		Command ID			Space	Variable	Carriage return

ADDITIONAL INFORMATION

SET Command

Type	Category	Parameter	CMD		Hex Code CMD	Response	
						Success	Failed
SET	Power	Power off	~xx00 n	n=0	7E 30 30 30 30 20 30 0d	P	F
		Restart	~xx00 n	n=3	7E 30 30 30 30 20 33 0d	P	F
		Power on	~xx00 n	n=1	7E 30 30 30 30 20 31 0d	P	F
SET	Power Mode (standby)	Eco.	~xx114 n	n=0	7E 30 30 31 31 34 20 30 0d	P	F
		Active		n=1	7E 30 30 31 31 34 20 31 0d	P	F
SET	Treble	0 ~ 100	~xx95 n	n=0-100	7E 30 30 39 35 20 30 0d to 7E 30 30 39 35 20 31 30 30 0d	P	F
SET	Bass	0 ~ 100	~xx96 n	n=0-100	7E 30 30 39 36 20 30 0d to 7E 30 30 39 36 20 31 30 30 0d	P	F
SET	Balance	0 ~ 100	~xx99 n	n=0-100	7E 30 30 39 39 20 30 0d to 7E 30 30 39 39 20 31 30 30 0d	P	F
SET	Contrast	0 ~ 100	~xx22 n	n=0-100	7E 30 30 32 32 20 30 0d to 7E 30 30 32 32 20 31 30 30 0d	P	F
SET	Brightness	0 ~ 100	~xx21 n	n=0-100	7E 30 30 32 31 20 30 0d to 7E 30 30 32 31 20 31 30 30 0d	P	F
SET	Sharpness	0 ~ 100	~xx23 n	n=0-100	7E 30 30 32 33 20 30 0d to 7E 30 30 32 33 20 31 30 30 0d	P	F
SET	Sound Mode	Standard	~xx252 n	n=1	7E 30 30 32 35 32 20 31 0d	P	F
		Meeting		n=4	7E 30 30 32 35 32 20 34 0d	P	F
		User		n=2	7E 30 30 32 35 32 20 32 0d	P	F
		Classroom		n=3	7E 30 30 32 35 32 20 33 0d	P	F
		Movie		n=5	7E 30 30 32 35 32 20 35 0d	P	F
SET	Volume	0 ~ 100	~xx81 n	n=0-100	7E 30 30 38 31 20 30 0d to 7E 30 30 38 31 20 31 30 30 0d	P	F
SET	Video Mute	Off	~xx13 n	n=0	7E 30 30 31 33 20 30 0d	P	F
		On		n=1	7E 30 30 31 33 20 31 0d	P	F
SET	Mute	Off	~xx80 n	n=0	7E 30 30 38 30 20 30 0d	P	F
		On		n=1	7E 30 30 38 30 20 31 0d	P	F
SET	Input Source	HDMI1	~xx12 n	n=1	7E 30 30 31 32 20 31 0d	P	F
		HDMI2		n=15	7E 30 30 31 32 20 31 35 0d	P	F
		HDMI Front		n=26	7E 30 30 31 32 20 32 36 0d	P	F
		VGA		n=5	7E 30 30 31 32 20 35 0d	P	F
		Solot in PC		n=25	7E 30 30 31 32 20 32 35 0d	P	F
		Android		n=24	7E 30 30 31 32 20 32 34 0d	P	F
		Display		n=20	7E 30 30 31 32 20 32 30 0d	P	F
SET	Aspect Ratio	4:3	~xx60 n	n=1	7E 30 30 36 30 20 31 0d	P	F
		16:9		n=2	7E 30 30 36 30 20 32 0d	P	F
		PTP		n=14	7E 30 30 36 30 20 31 34 0d	P	F
SET	Language	English	~xx70 n	n=1	7E 30 30 37 30 20 31 0d	P	F
		Français		n=3	7E 30 30 37 30 20 33 0d	P	F

ADDITIONAL INFORMATION

Type	Category	Parameter	CMD		Hex Code CMD	Response	
						Success	Failed
SET	Language	Español	~xx70 n	n=5	7E 30 30 37 30 20 35 0d	P	F
		Traditional Chinese		n=13	7E 30 30 37 30 20 31 33 0d	P	F
		Simplified Chinese		n=14	7E 30 30 37 30 20 31 34 0d	P	F
		Português		n=6	7E 30 30 37 30 20 36 0d	P	F
		German		n=2	7E 30 30 37 30 20 32 0d	P	F
		Dutch		n=8	7E 30 30 37 30 20 38 0d	P	F
		Polish		n=7	7E 30 30 37 30 20 37 0d	P	F
		Russia		n=17	7E 30 30 37 30 20 31 37 0d	P	F
		Czech		n=19	7E 30 30 37 30 20 31 39 0d	P	F
		Danish		n=10	7E 30 30 37 30 20 31 30 0d	P	F
		Swedish		n=9	7E 30 30 37 30 20 39 0d	P	F
		Italian		n=4	7E 30 30 37 30 20 34 0d	P	F
		Turkish		n=22	7E 30 30 37 30 20 32 32 0d	P	F
		Arabic		n=20	7E 30 30 37 30 20 32 30 0d	P	F
Romania	n=27	7E 30 30 37 30 20 32 37 0d	P	F			
SET	Picture Mode	Presentation	~xx20 n	n=1	7E 30 30 32 30 20 31 0d	P	F
		Bright		n=2	7E 30 30 32 30 20 32 0d	P	F
		Cinema		n=3	7E 30 30 32 30 20 33 0d	P	F
		User		n=5	7E 30 30 32 30 20 35 0d	P	F
		HDR		n=21	7E 30 30 32 30 20 32 31 0d	P	F
SET	Tint	0 ~ 100	~xx44 n	n=0-100	7E 30 30 34 34 20 30 0d to 7E 30 30 34 34 20 31 30 30 0d	P	F
SET	Color	0 ~ 100	~xx45 n	n=0-100	7E 30 30 34 35 20 30 0d to 7E 30 30 34 35 20 31 30 30 0d	P	F
SET	Sharpness	0 ~ 100	~xx23 n	n=0-100	7E 30 30 32 33 20 30 0d to 7E 30 30 32 33 20 31 30 30 0d	P	F
SET	Backlight	0 ~ 100	~xx251 n	n=0-100	7E 30 30 32 35 31 20 30 0d to 7E 30 30 32 35 31 20 31 30 30 0d	P	F
SET	Color Temp	Cool	~xx36 n	n=2	7E 30 30 33 36 20 32 0d	P	F
		Standard		n=1	7E 30 30 33 36 20 31 0d	P	F
		Warm		n=4	7E 30 30 33 36 20 34 0d	P	F
SET	Freeze	Unfreeze	~xx04 n	n=0	7E 30 30 30 34 20 30 0d	P	F
		Freeze		n=1	7E 30 30 30 34 20 31 0d	P	F
SET	Pixel shift interval (min)	Off	~xx250 n	n=0	7E 30 30 32 35 30 20 30 0d	P	F
		2		n=2	7E 30 30 32 35 30 20 32 0d	P	F
		3		n=3	7E 30 30 32 35 30 20 33 0d	P	F
		5		n=5	7E 30 30 32 35 30 20 35 0d	P	F
		30		n=30	7E 30 30 32 35 30 20 33 30 0d	P	F
		60		n=60	7E 30 30 32 35 30 20 36 30 0d	P	F
SET	Reomte control command	Vol +	~xx140 n	n=17	7E 30 30 31 34 30 20 31 37 0d	P	F
		Vol -		n=18	7E 30 30 31 34 30 20 31 38 0d	P	F

ADDITIONAL INFORMATION

Type	Category	Parameter	CMD		Hex Code CMD	Response	
						Success	Failed
SET	Remote control command	Remote UP	~xx140 n	n=10	7E 30 30 31 34 30 20 31 30 0d	P	F
		Remote DOWN		n=14	7E 30 30 31 34 30 20 31 34 0d	P	F
		Remote LEFT		n=11	7E 30 30 31 34 30 20 31 31 0d	P	F
		Remote RIGHT		n=13	7E 30 30 31 34 30 20 31 33 0d	P	F
		Remote OK		n=12	7E 30 30 31 34 30 20 31 32 0d	P	F
		Remote Menu Key		n=20	7E 30 30 31 34 30 20 32 30 0d	P	F
		Remote Input source		n=47	7E 30 30 31 34 30 20 34 37 0d	P	F
		Remote Exit		n=74	7E 30 30 31 34 30 20 37 34 0d	P	F

GET Command

Type	Category	CMD		Hex Code CMD	Response		
					Success	Parameter	Failed
GET	Power	~xx124 n	n=1	7E 30 30 31 32 34 20 31 0D	OK0	Power off	F
					OK1	Power on	F
GET	Contrast	~xx126 n	n=1	7E 30 30 31 32 36 20 31 0D	OK0-100	0-100	F
GET	Brightness	~xx125 n	n=1	7E 30 30 31 32 35 20 31 0D	OK0-100	0-100	F
GET	Volume	~xx120 n	n=1	7E 30 30 31 32 30 20 31 0D	OK0-100	0-100	F
GET	Video Mute	~xx363 n	n=1	7E 30 30 33 36 33 20 31 0D	OK0	Off	F
					OK1	On	F
GET	Mute	~xx356 n	n=1	7E 30 30 33 35 36 20 31 0D	OK0	Off	F
					OK1	On	F
GET	Sound Mode	~xx139	n=1	7E 30 30 31 33 39 20 31 0D	OK1	Standard	F
					OK2	User	F
					OK3	Classroom	F
					OK4	Meeting	F
					OK5	Movie	F
GET	Input Source	~xx121 n	n=1	7E 30 30 31 32 31 20 31 0D	OK7	HDMI1	F
					OK8	HDMI2	F
					OK22	HDMI Front	F
					OK2	VGA	F
					OK20	Android	F
					OK21	Slot in PC	F
					OK15	Displayport	F

ADDITIONAL INFORMATION

Type	Category	CMD		Hex Code CMD	Response		
					Success	Parameter	Failed
GET	Aspect Ratio	~xx127 n	n=1	7E 30 30 31 32 37 20 31 0D	OK1	4:3	F
					OK2	16:9	F
					OK14	PTP	F
GET	Picture Mode	~xx123 n	n=1	7E 30 30 31 32 33 20 31 0D	OK1	Presentation	F
					OK2	Bright	F
					OK3	Cinema	F
					OK5	User	F
					OK21	HDR	F
GET	Color Temp	~xx128 n	n=1	7E 30 30 31 32 38 20 31 0D	OK1	Cool	F
					OK0	Standard	F
					OK3	Warm	F
GET	WLAN status	~xx451 n	n=1	7E 30 30 34 35 31 20 31 0D	OK0	Disconnected	F
					OK1	Connected	F
GET	WLAN Mac address	~xx555 n	n=2	7E 30 30 35 35 35 20 32 0D	Oknn:nn:nn:nn:nn	Mac Address	F
GET	WLAN IP address	~xx451 n	n=2	7E 30 30 34 35 31 20 32 0D	Oknnn:nnn:nnn:nnn	IP address	F
GET	LAN status	~xx87 n	n=1	7E 30 30 38 37 20 31 0D	OK0	Disconnected	F
					OK1	Connected	F
GET	LAN Mac address	~xx555 n	n=1	7E 30 30 35 35 35 20 31 0D	Oknn:nn:nn:nn:nn	Mac Address	F
GET	LAN IP address	~xx87 n	n=3	7E 30 30 38 37 20 33 0D	Oknnn:nnn:nnn:nnn	IP address	F
GET	FW version	~xx122 n	n=1	7E 30 30 31 32 32 20 31 0D	Oknnnnnnnnnnnnnnnn (ex. 20190926164814)	FW version	F
GET	Usage hour	~xx108 n	n=1	7E 30 30 31 30 38 20 31 0D	Oknnnnn	Suage hours	F
GET	Device type	~xx149 n	n=1	7E 30 30 31 34 39 20 31 0D	OK2	Device type = IFP	F
GET	Information string	~xx150 n	n=1	7E 30 30 31 35 30 20 31 0D	OKabbbbbccddddee (Refer to Note ^(*))		F
			n=2	7E 30 30 31 35 30 20 32 0D	Oknnn	Device native resolution	F
			n=3	7E 30 30 31 35 30 20 33 0D	Oknnn (ex. OKHDMI1)	Input source	F
			n=4	7E 30 30 31 35 30 20 34 0D	Oknnn (ex. OK1920x1080)	Source resoluition	F
			n=16	7E 30 30 31 35 30 20 31 36 0D	OK0	Power mode (standby) = Eco.	F
			n=16	7E 30 30 31 35 30 20 31 36 0D	OK1	Power mode (standby) = Active	F
			n=17	7E 30 30 31 35 30 20 31 37 0D	OK0	DHCP = Of	F
					OK1	DHCP = On	F
			n=18	7E 30 30 31 35 30 20 31 38 0D	Oknnn (ex. OK48)	System temperature	F
			n=19	7E 30 30 31 35 30 20 31 39 0D	Oknnn (ex. OK60Hz)	Source refresh rate	F

ADDITIONAL INFORMATION

Note: (*1)

Power	Running Time	Input Source	Firmware Version	Display Mode
<ul style="list-style-type: none"> <i>a=0</i> Power Off <i>a=1</i> Power On 	Usage hours = <i>nnnnn</i>	<ul style="list-style-type: none"> <i>cc=02</i> VGA1 <i>cc=07</i> HDMI1 <i>cc=08</i> HDMI2 <i>cc=10</i> Compnent <i>cc=20</i> HDMI Front <i>cc=15</i> DisplayPort <i>cc=18</i> Android <i>cc=19</i> Slot in PC 	# # # #	<ul style="list-style-type: none"> <i>ee=01</i> Presentation <i>ee=02</i> Bright <i>ee=03</i> Cinema <i>ee=05</i> User <i>ee=21</i> HDR





LED Indicator

Power LED Color & Behavior	Status
Solid Red	Standby mode
Solid White	Power on
Flash Red then White continuously	Backlight off

ADDITIONAL INFORMATION

Troubleshooting

If you experience a problem with your device, please refer to the following information. If a problem persists, please contact your local reseller or service center.

-  *No picture or sound.*
- Make sure all signal and power connections are properly connected.
 - Make sure the correct input mode is selected. Refer to the “Selecting an Input Source” section.
 - Make sure the IFP is not turned off.
 - Turn off the mute function.
 - Make sure the volume is not set to the minimum level.
-  *The IFP automatically shuts down.*
- Check whether there is a sudden power outage.
 - Make sure the power cord is not disconnected.
-  *The signal is out of range*
- The signal may be incompatible. Refer to the “Supported Timing List” section.
 - For the VGA input source, try the automatic screen adjustment or adjust the **Frequency** and **Phase** settings in **OSD > Signal** menu.
-  *The touch panel does not respond*
- Make sure the screen is not exposed to direct sunlight or other strong light.
 - For the external device connection, make sure the USB cable is properly connected to the Touch USB port of the IFP.
-  *If the remote control does not work*
- Check that the operating angle of the remote control is pointed within $\pm 30^\circ$ to the IR receiver on the IFP.
 - Make sure there are no obstructions between the remote control and the IFP. The distance between the remote control and the IR sensor window should not be longer than 8 meters.
 - Make sure batteries are inserted correctly and replace the batteries if they are depleted. Refer to the “Installing/Replacing the Remote Control Batteries” section.

ADDITIONAL INFORMATION

Maintenance

Proper routine maintenance can help with early fault detection and keep the IFP looking like new.

IMPORTANT! *Before cleaning and performing any maintenance task, make sure to unplug the power cord from the power outlet to prevent electric shock.*

Cleaning the Screen

- When the screen requires cleaning, please unplug the power cord first.
- Please use a soft, dust-free, dry cloth to wipe the screen.
- Do not use water or a spray cleaner to clean the IFP.
- Please contact the service center for internal cleaning of the IFP.

Clean the Front Frame

Use a dry, soft, lint-free cloth to wipe the front frame.



ADDITIONAL INFORMATION

Optoma Global Offices

For service or support, please contact your local office.



USA

47697 Westinghouse Drive,
Fremont, CA 94539, USA
www.optomausa.com

 888-289-6786
 510-897-8601
 services@optoma.com



Canada

47697 Westinghouse Drive,
Fremont, CA 94539, USA
www.optomausa.com

 888-289-6786
 510-897-8601
 services@optoma.com

Latin America

47697 Westinghouse Drive,
Fremont, CA 94539, USA
www.optomausa.com

 888-289-6786
 510-897-8601
 services@optoma.com



Europe

Unit 1, Network 41, Bourne End Mills,
Hemel Hempstead, Herts,
HP1 2UJ, United Kingdom
www.optoma.eu
Service Tel : +44 (0)1923 691865

 +44 (0) 1923 691 800
 +44 (0) 1923 691 888
 service@tsc-europe.com



Benelux BV

Randstad 22-123
1316 BW Almere
The Netherlands
www.optoma.nl

 +31 (0) 36 820 0252
 +31 (0) 36 548 9052



France

Bâtiment E
81-83 avenue Edouard Vaillant
92100 Boulogne Billancourt, France

 +33 1 41 46 12 20
 +33 1 41 46 94 35
 savoptoma@optoma.fr



Spain

C/ José Hierro,36 Of. 1C
28522 Rivas VaciaMadrid,
Spain

 +34 91 499 06 06
 +34 91 670 08 32



Deutschland

Wiesenstrasse 21 W
D40549 Düsseldorf,
Germany

 +49 (0) 211 506 6670
 +49 (0) 211 506 66799
 info@optoma.de

Scandinavia



Lerpeveien 25
3040 Drammen
Norway

 +47 32 98 89 90
 +47 32 98 89 99
 info@optoma.no

PO.BOX 9515
3038 Drammen
Norway

Korea

WOOMI TECH.CO.,LTD.
4F, Minu Bldg.33-14, Kangnam-Ku,
Seoul,135-815, KOREA
korea.optoma.com

 +82+2+34430004
 +82+2+34430005



Japan

東京都足立区綾瀬3-25-18
株式会社オーエス
コンタクトセンター:0120-380-495

 info@os-worldwide.com
www.os-worldwide.com



Taiwan

12F., No.213, Sec. 3, Beixin Rd.,
Xindian Dist., New Taipei City 231,
Taiwan, R.O.C.
www.optoma.com.tw

 +886-2-8911-8600
 +886-2-8911-6550
 services@optoma.com.tw
asia.optoma.com



Hong Kong

Unit A, 27/F Dragon Centre,
79 Wing Hong Street,
Cheung Sha Wan,
Kowloon, Hong Kong

 +852-2396-8968
 +852-2370-1222
www.optoma.com.hk

China

5F, No. 1205, Kaixuan Rd.,
Changning District
Shanghai, 200052, China

 +86-21-62947376
 +86-21-62947375
www.optoma.com.cn

